

Belirtilen sayı kadar güneşi keserek bulutların üzerine yapıştıralım.

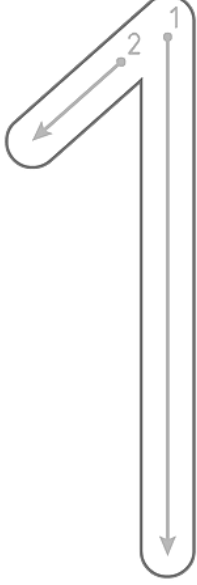

bir

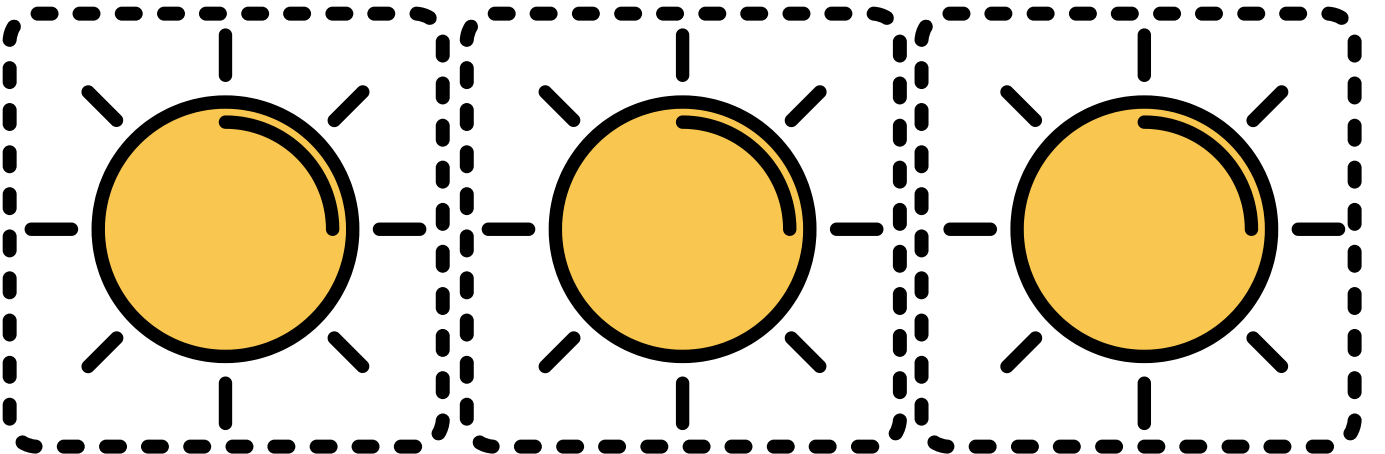
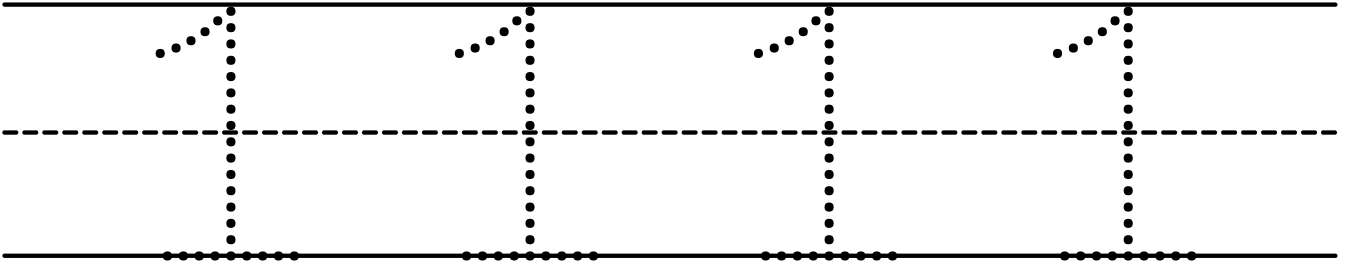

Belirtilen sayı kadar çorabı keserek askıya yapıştıralım.

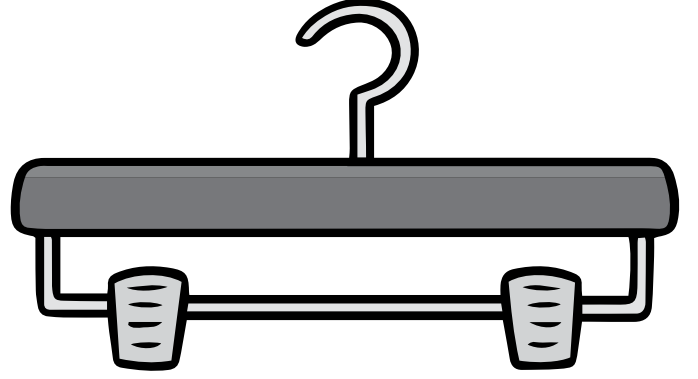
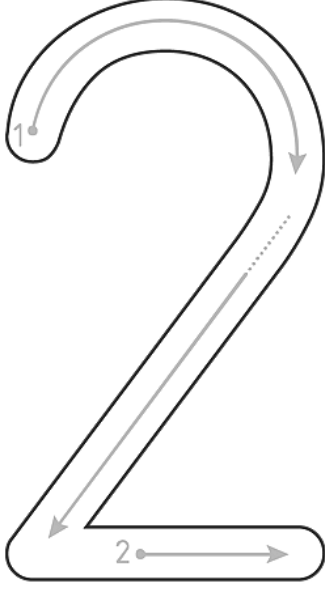

iki

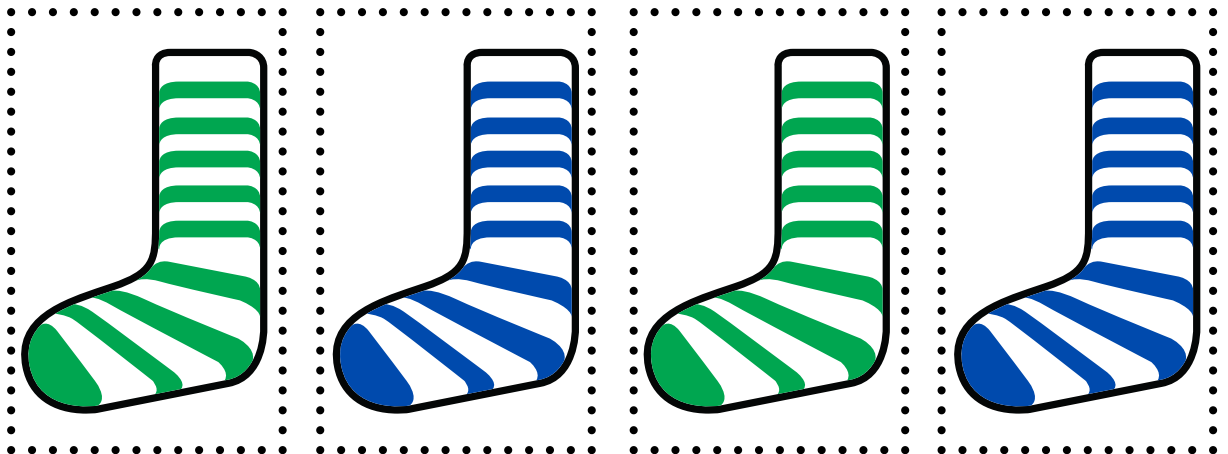
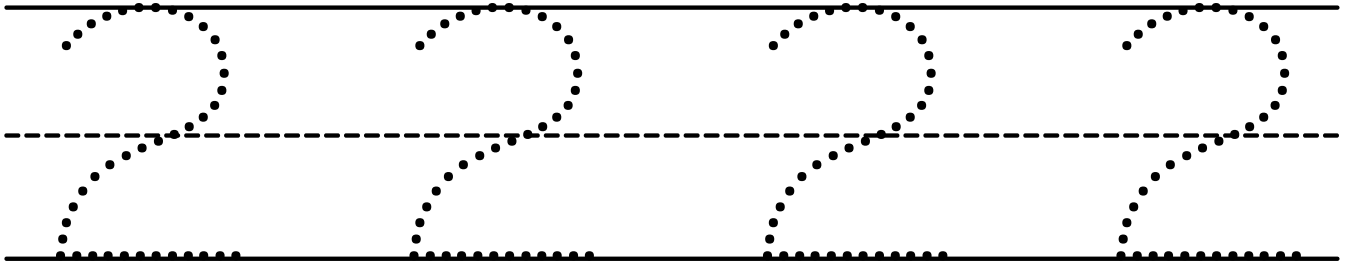

Belirtilen sayı kadar muzu keserek ağaca yapıştıralım.

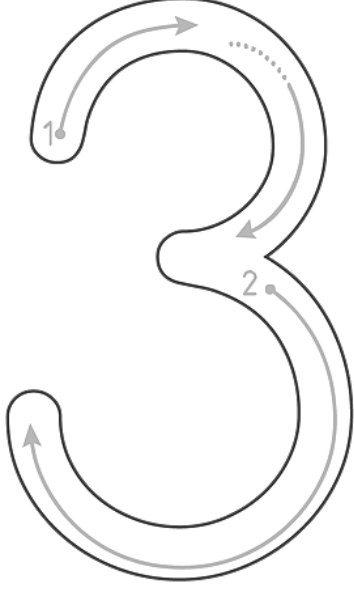

üç

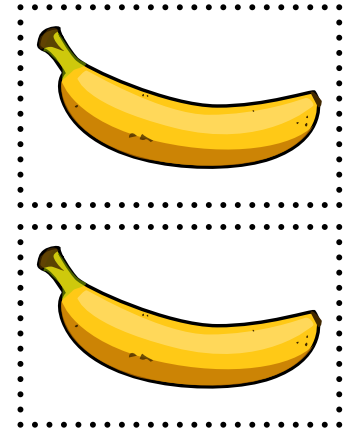
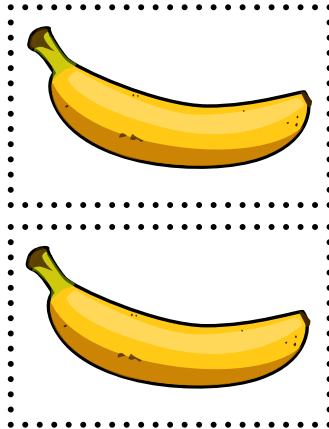
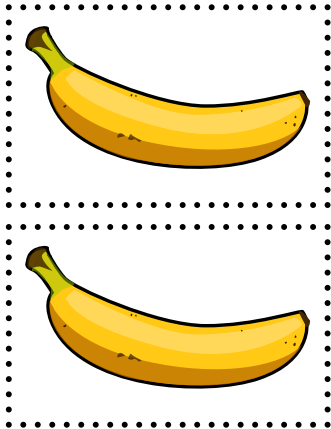
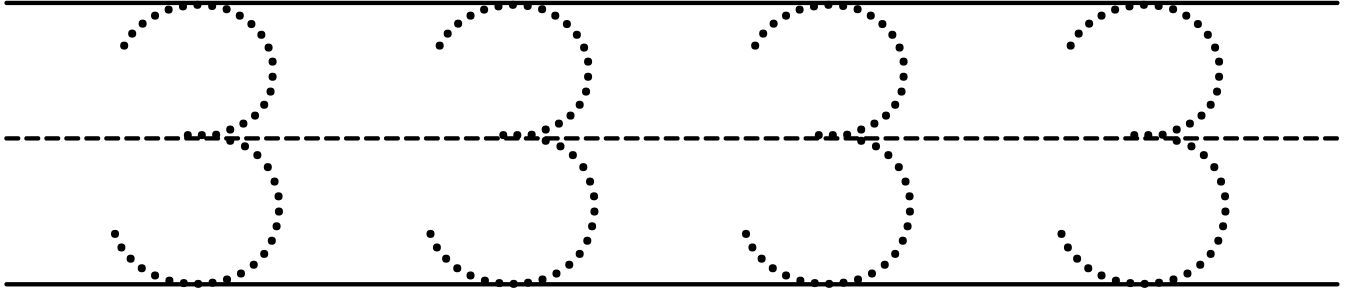

Belirtilen sayı kadar elmayı keserek ağaca yapıştıralım.

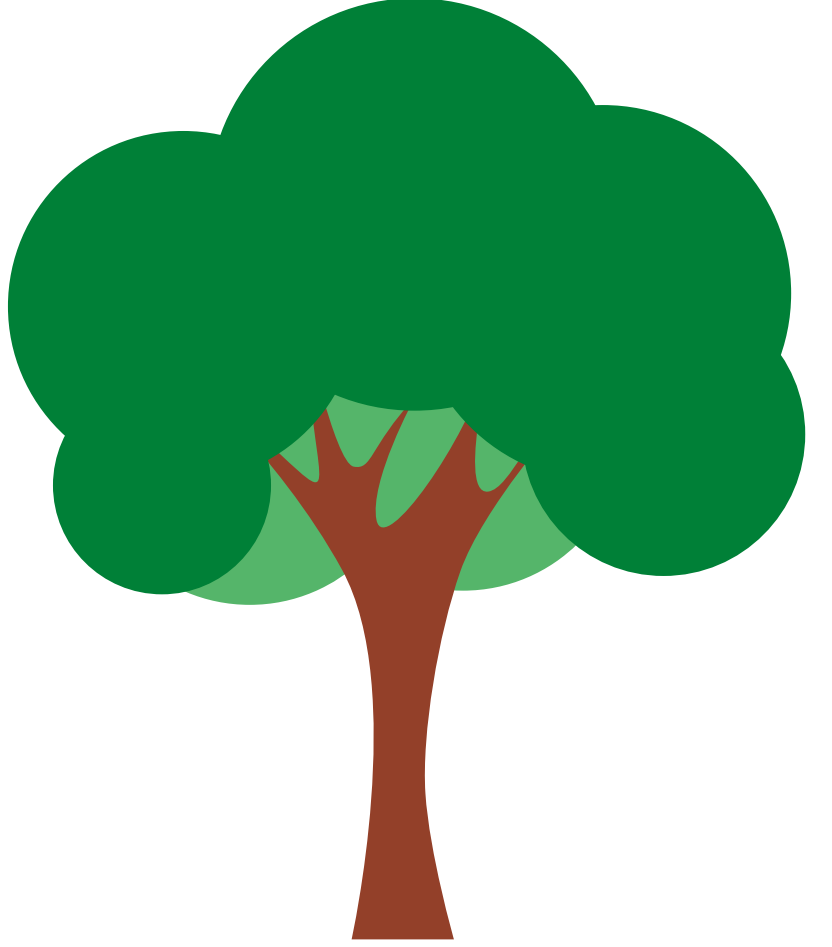
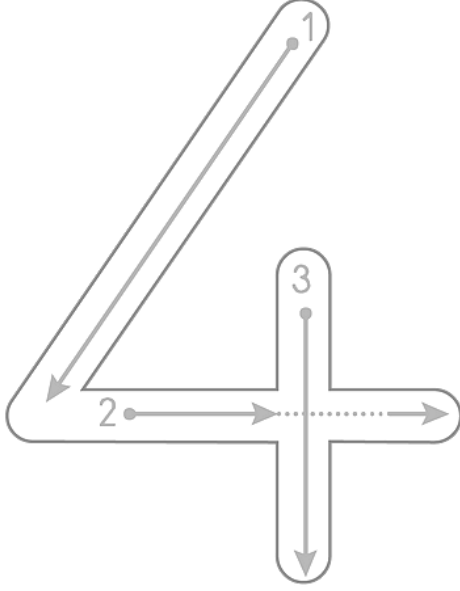

dört

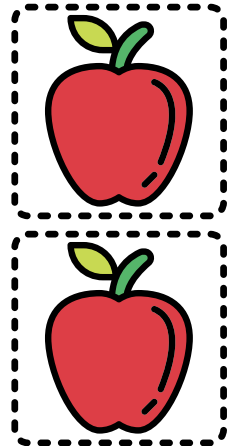
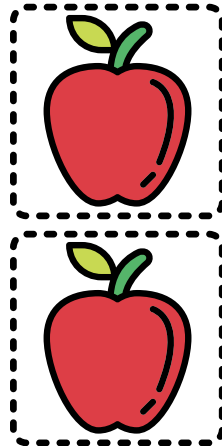
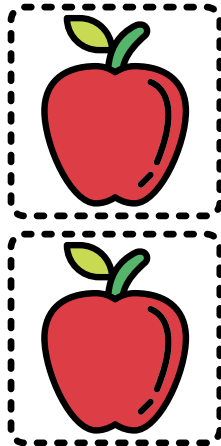
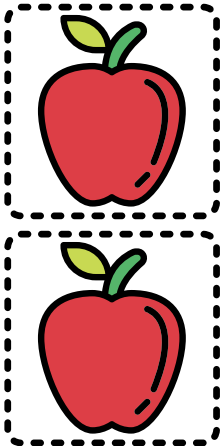
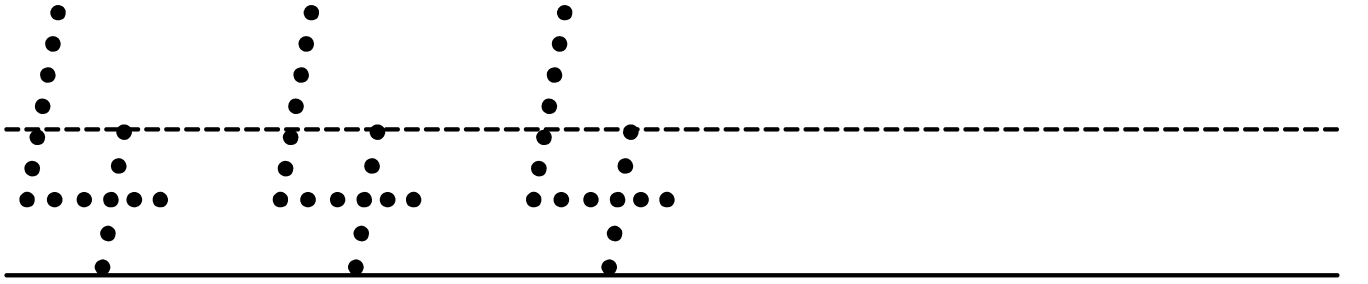

Belirtilen sayı kadar arıyı keserek kovana yapıştıralım.

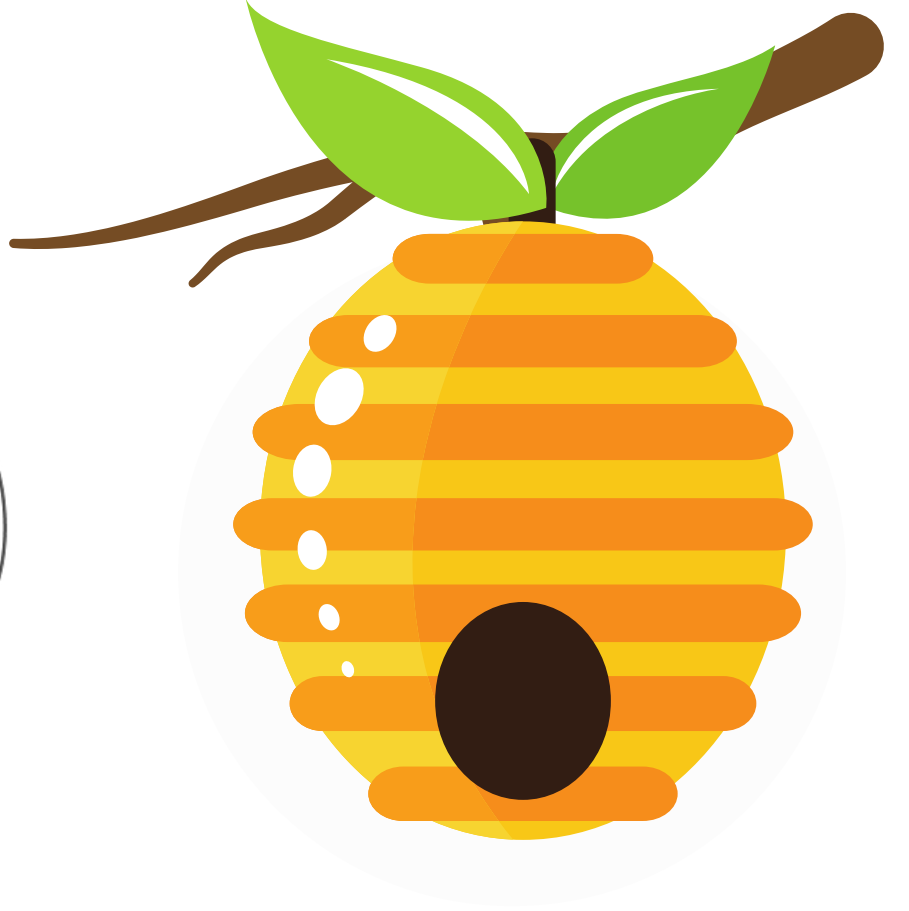
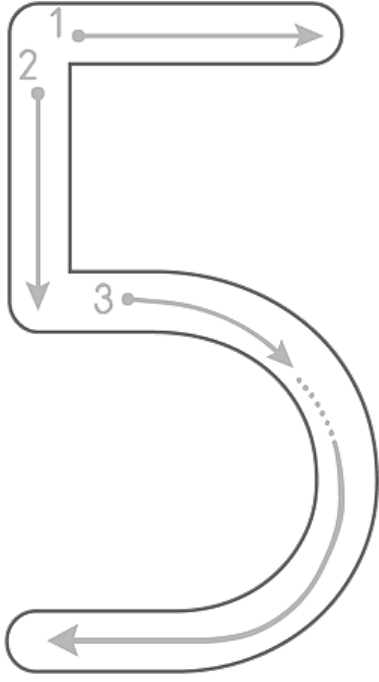

beş

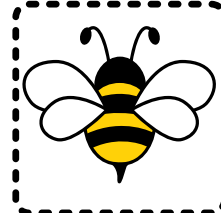
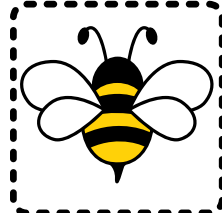
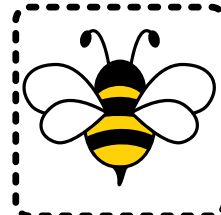
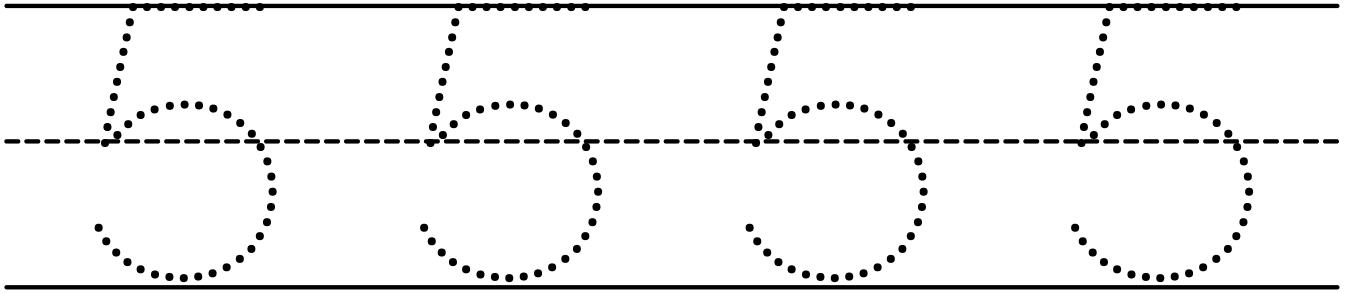

Belirtilen sayı kadar kelebeđi keserek bitkinin etrafına yapıştıralım.

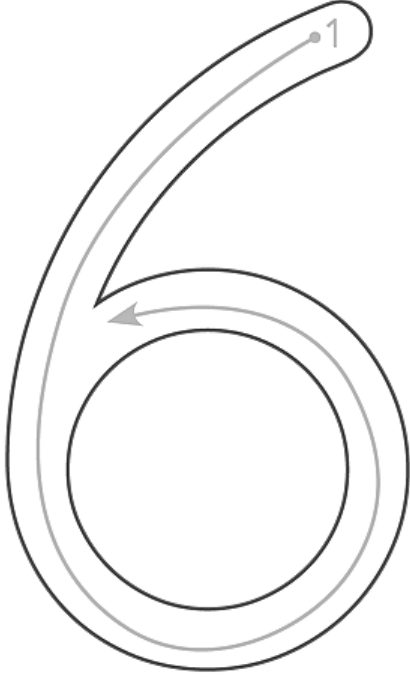

altı

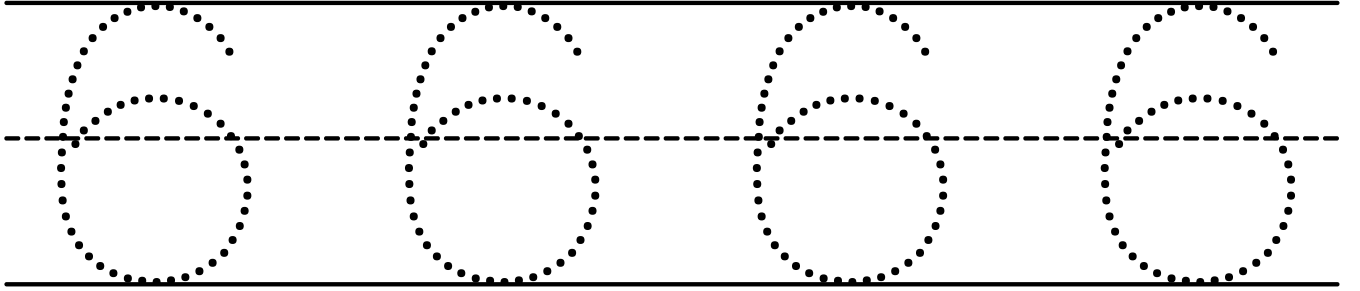
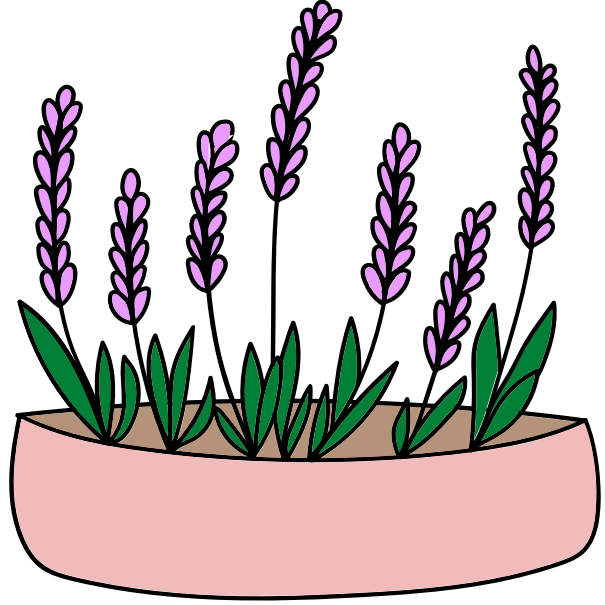

Belirtilen sayı kadar pizzayı keserek tabağa yapıştıralım.

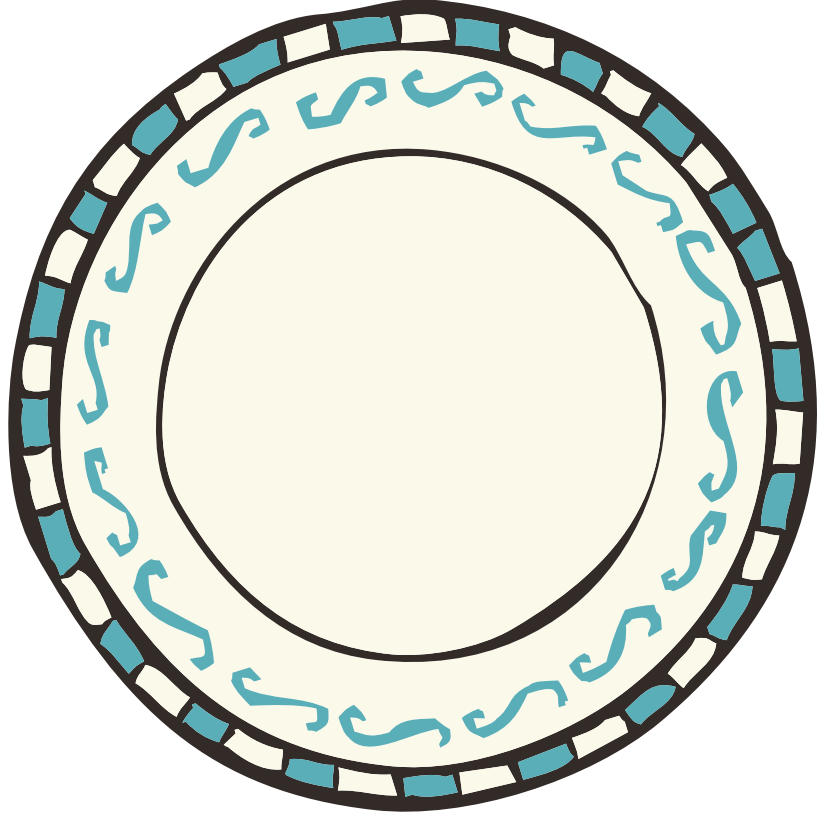
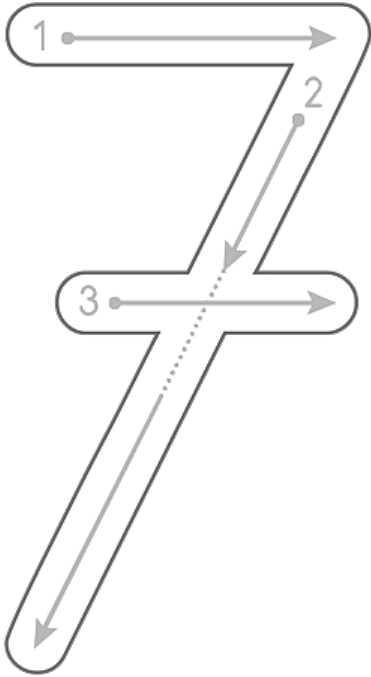

yedi

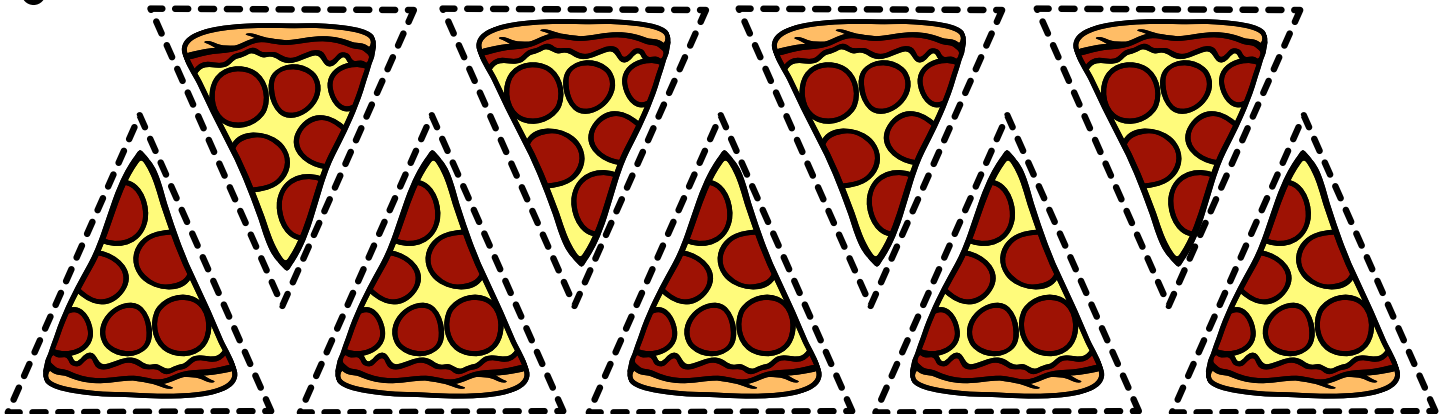
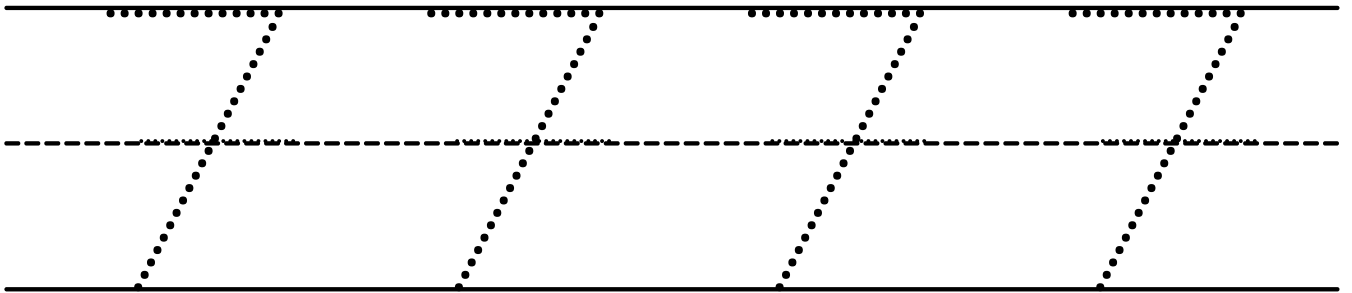

Belirtilen sayı kadar çileği keserek sepete yapıştıralım.

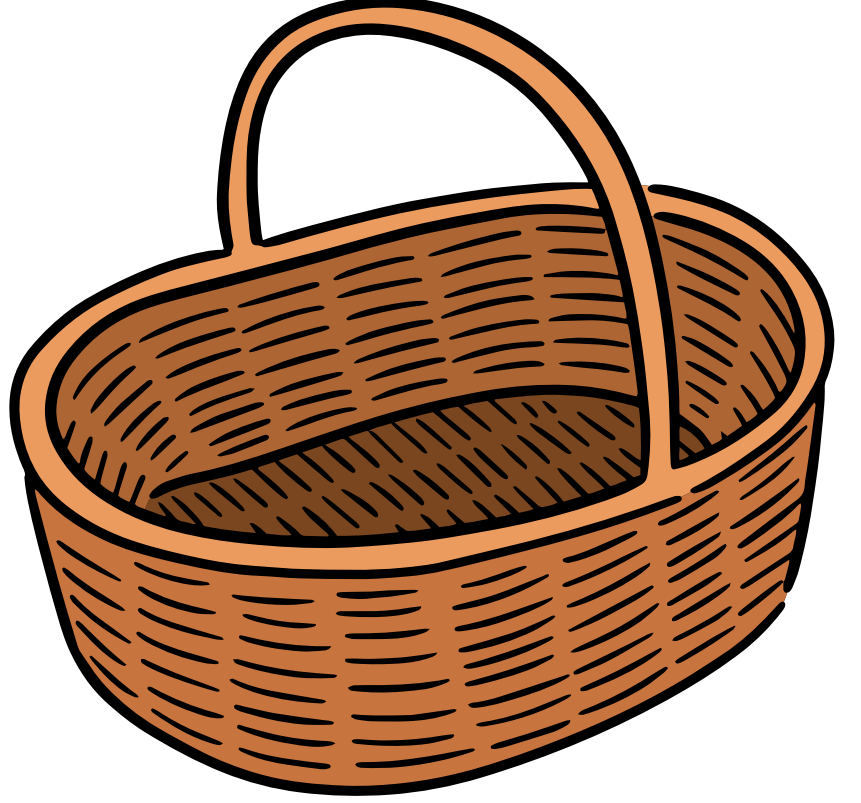
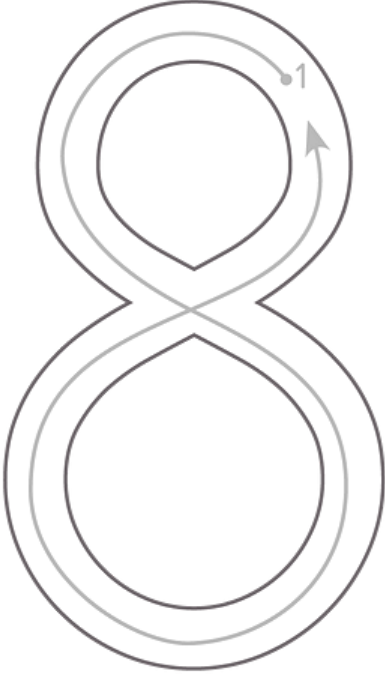

sekiz

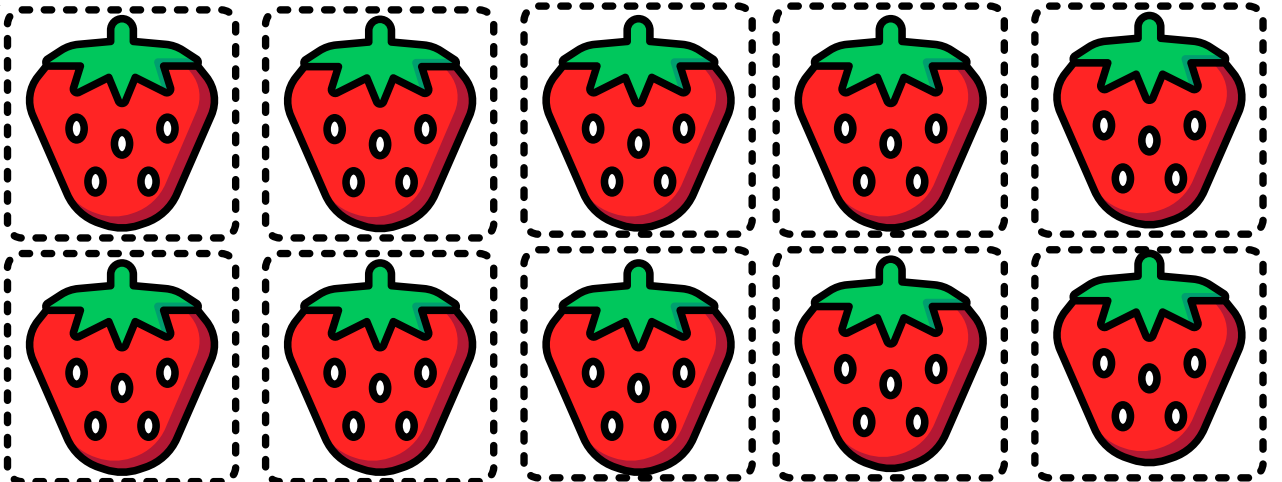
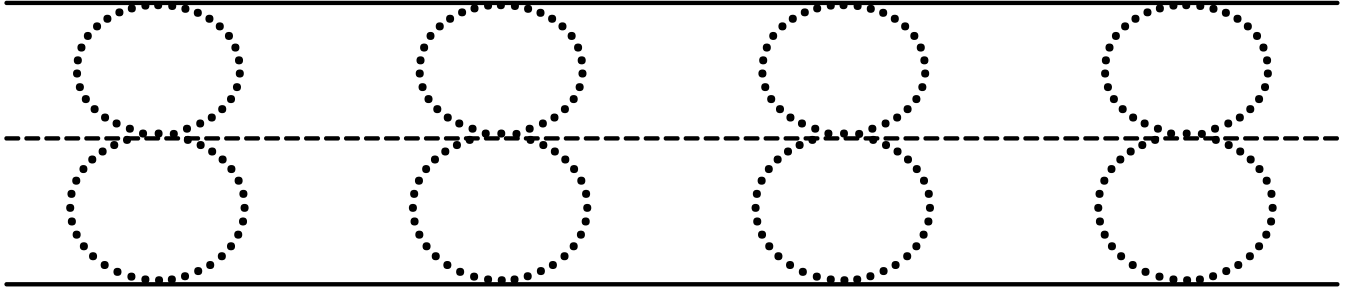

Belirtilen sayı kadar portakalı keserek ağaca yapıştıralım.

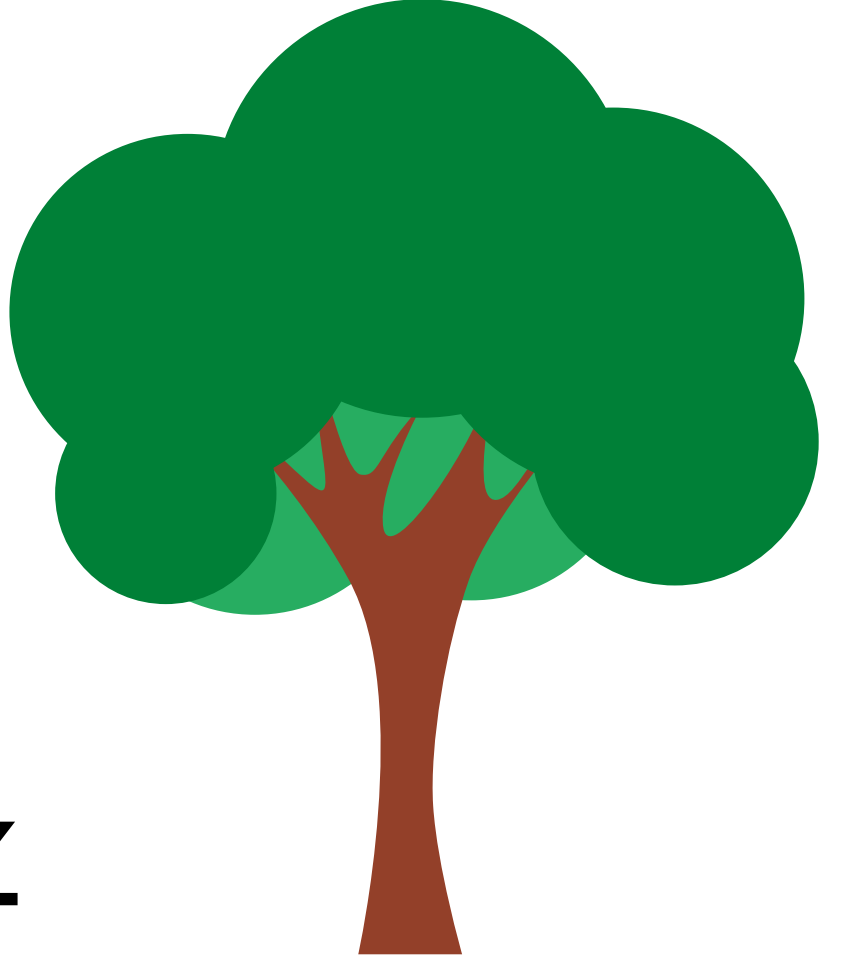
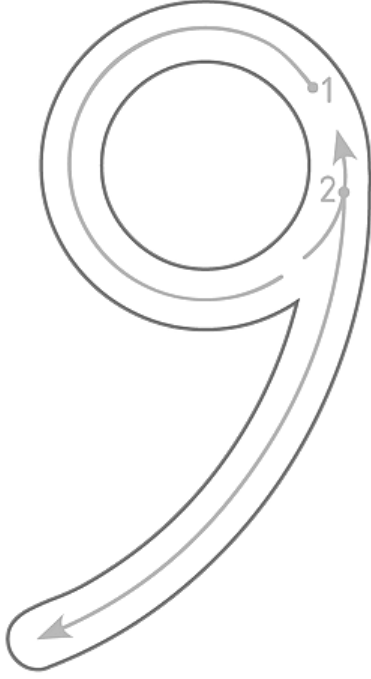

dokuz

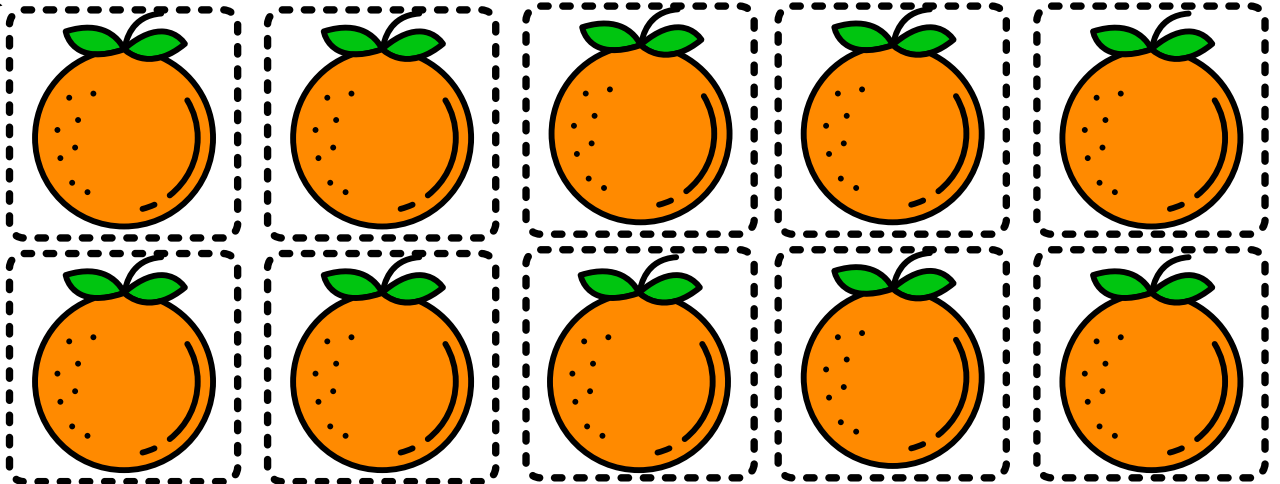
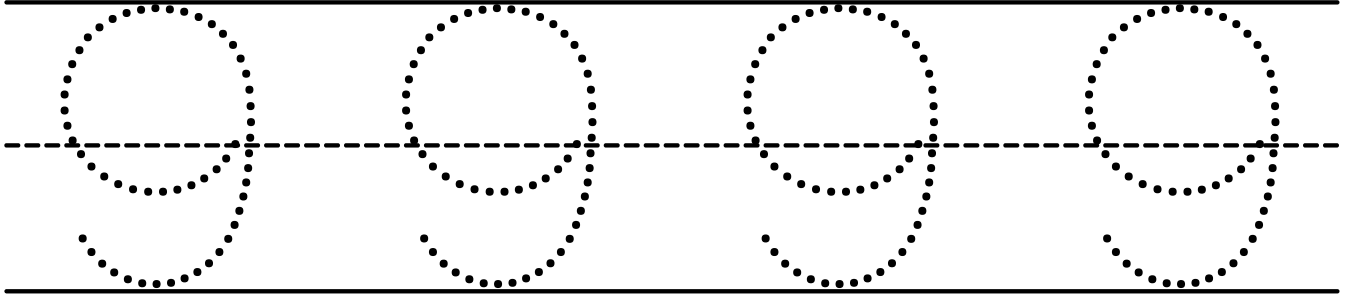

Belirtilen sayı kadar kurabiyeyi keserek kavanoza yapıştıralım.

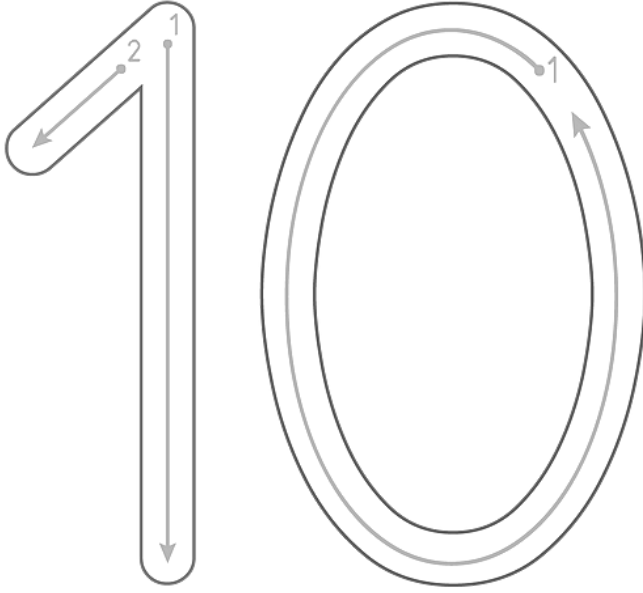

on

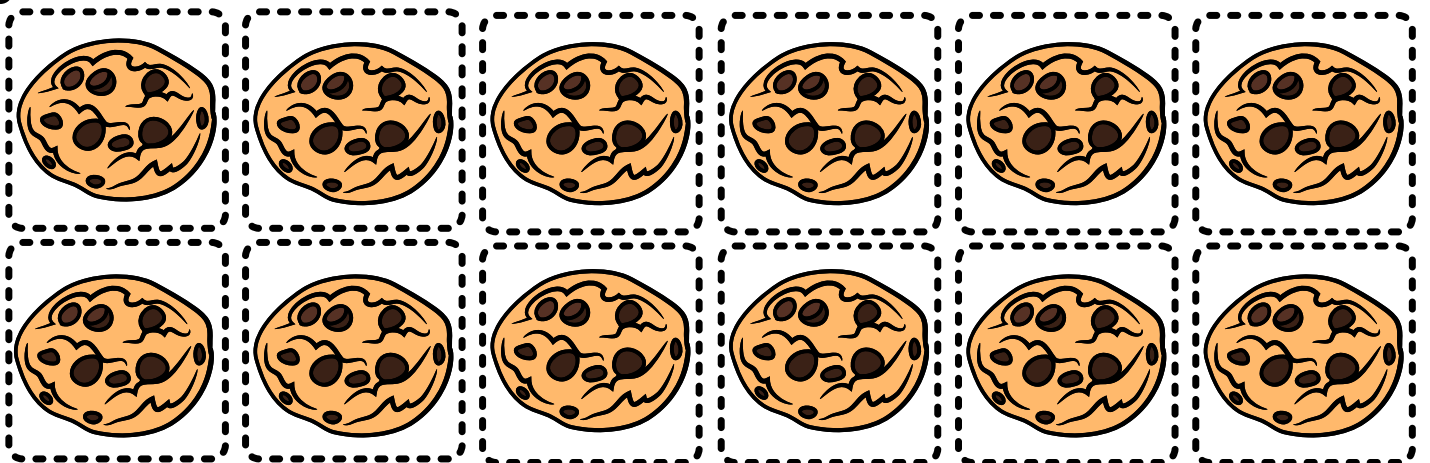
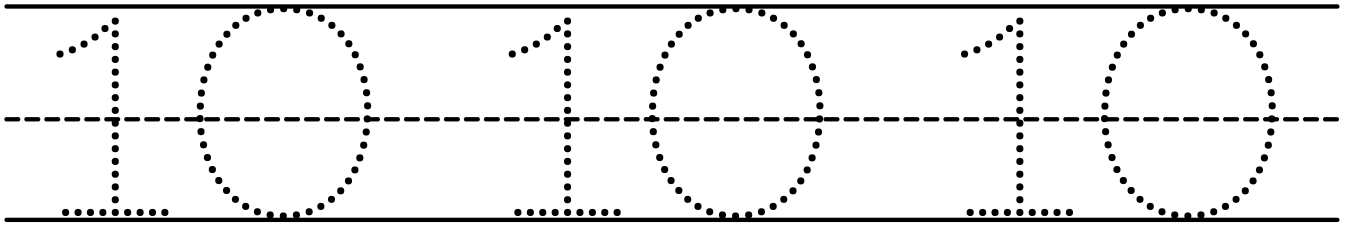

Belirtilen sayı kadar kalp şeklini keserek kavanoza yapıştıralım.

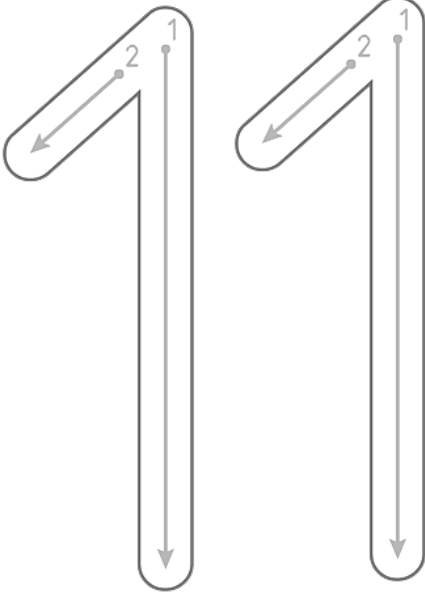

on bir

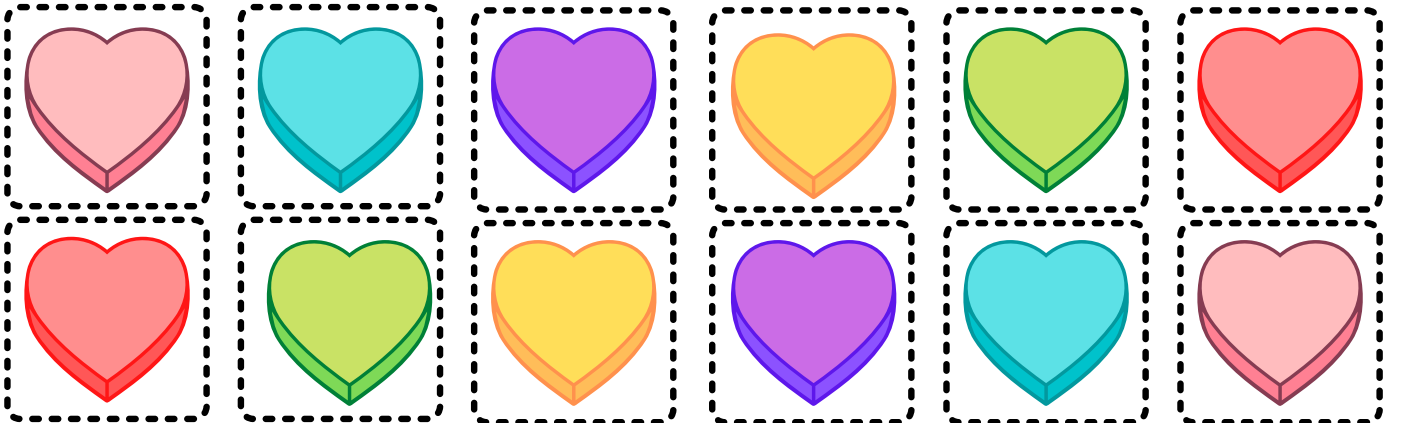
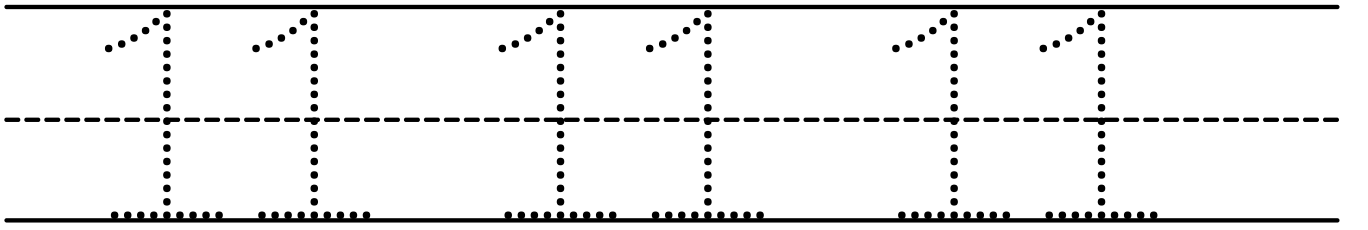

Belirtilen sayı kadar çiçeği keserek bukete yapıştıralım.

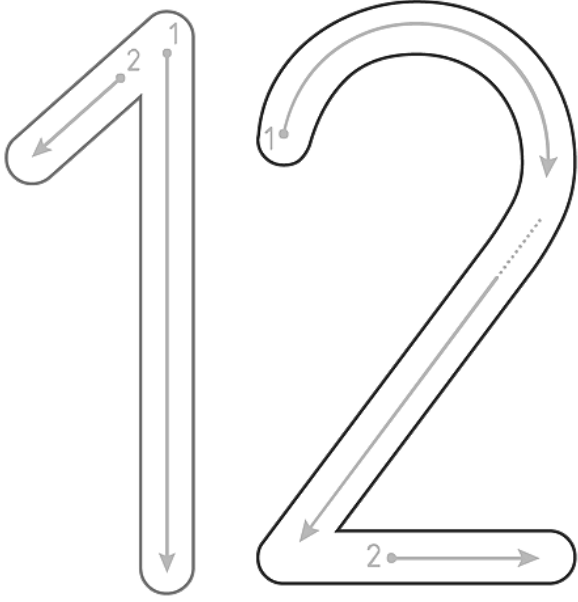

on iki

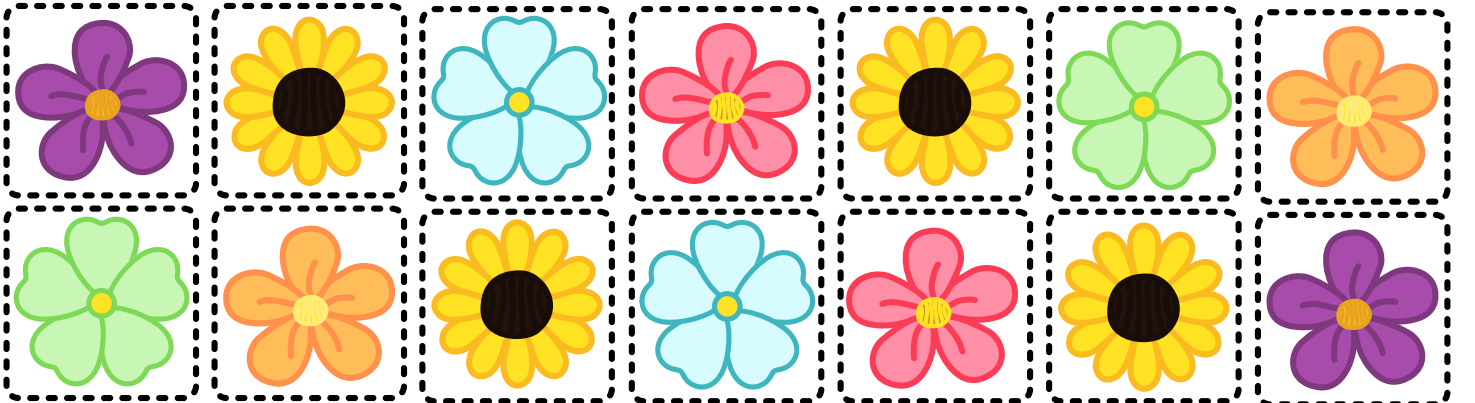
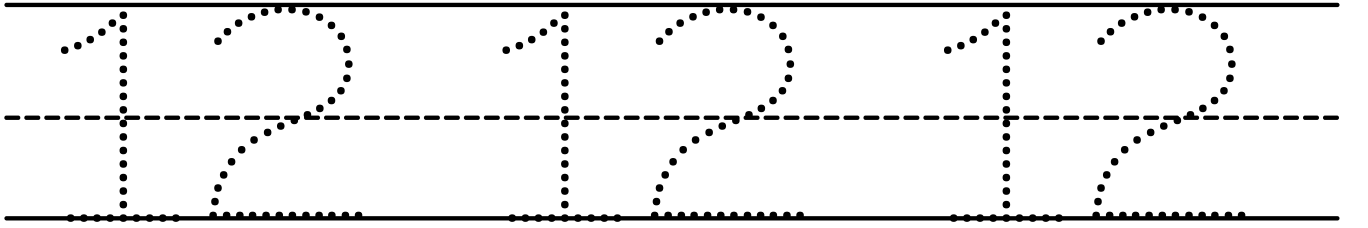
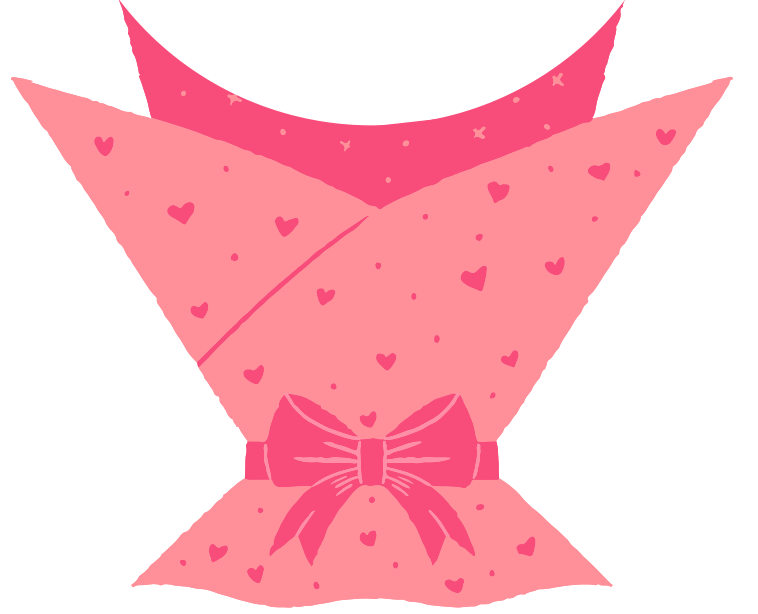

Belirtilen sayı kadar ikolatayı keserek kutuya yapıştıralım.



on üç

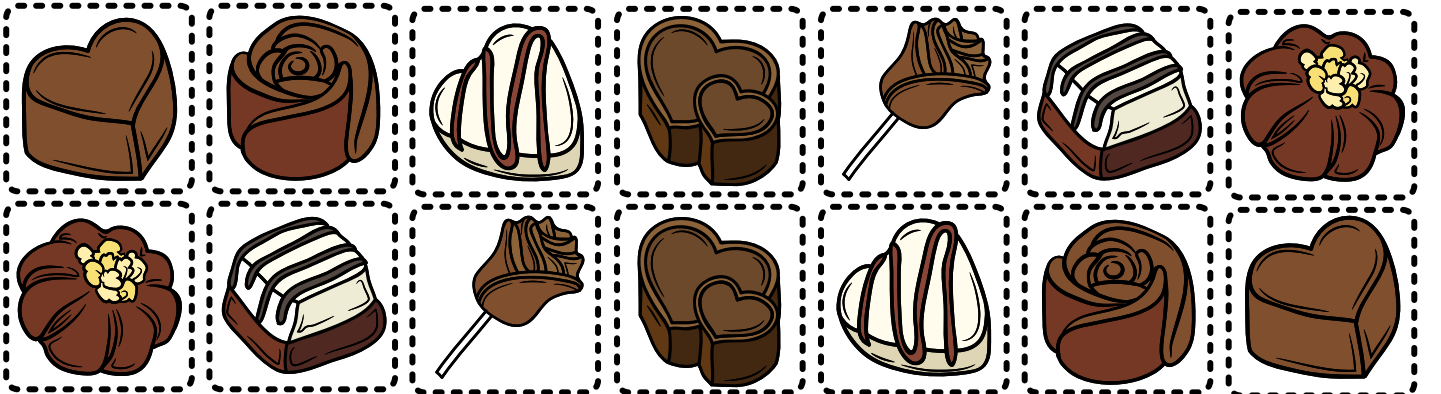
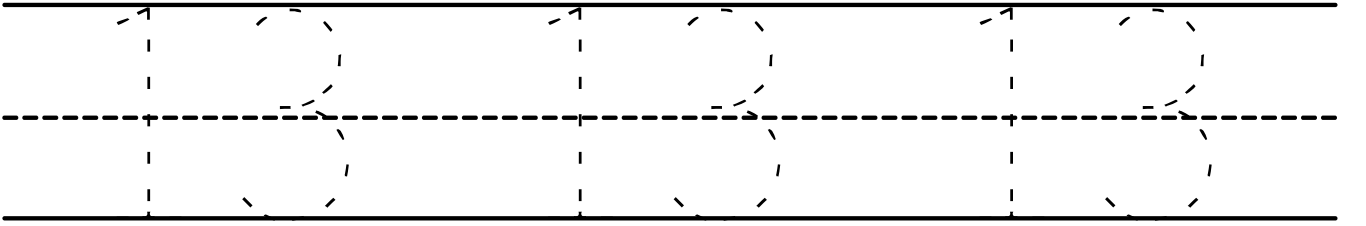
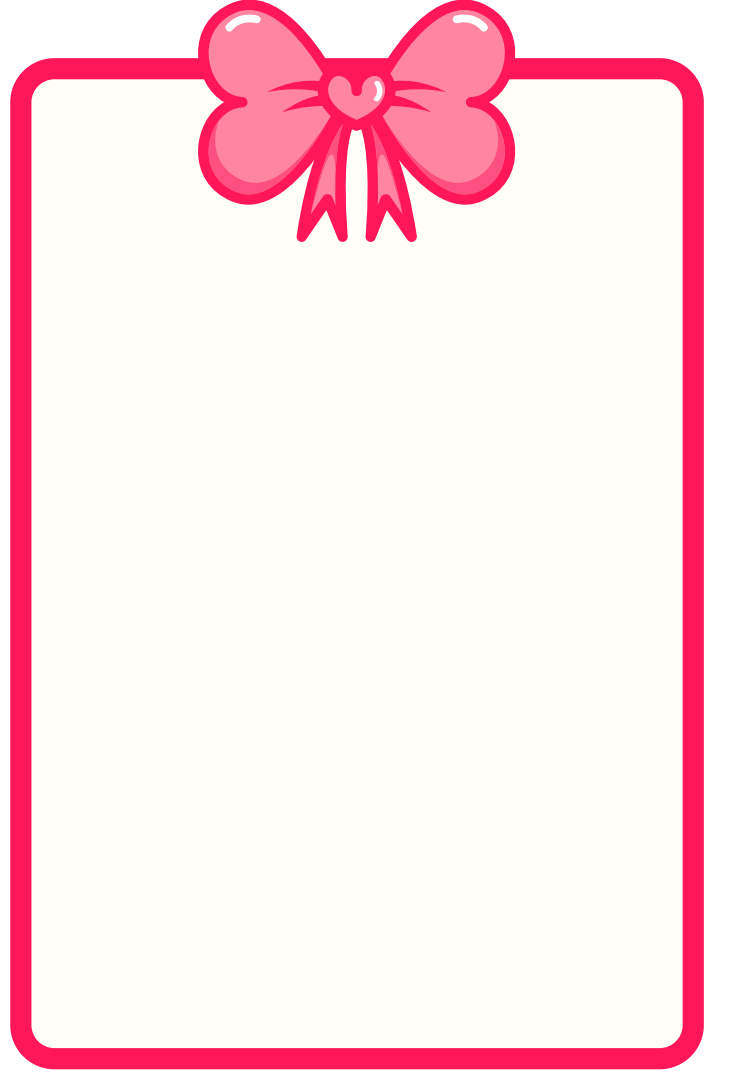

Belirtilen sayı kadar mumu keserek pastaya yapıştıralım.

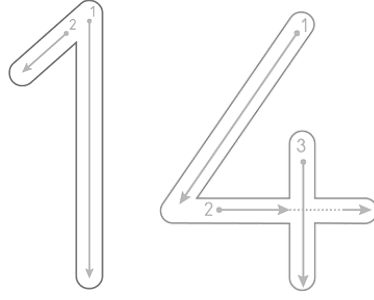

on dört

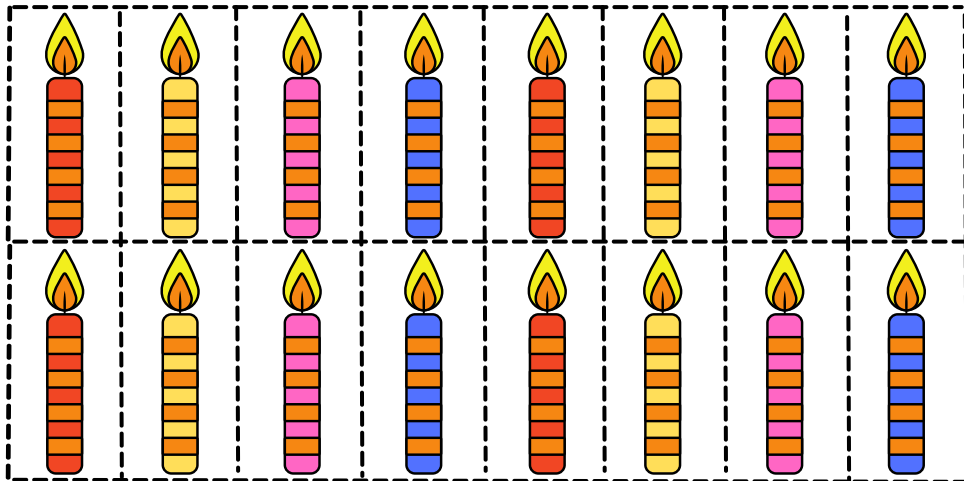
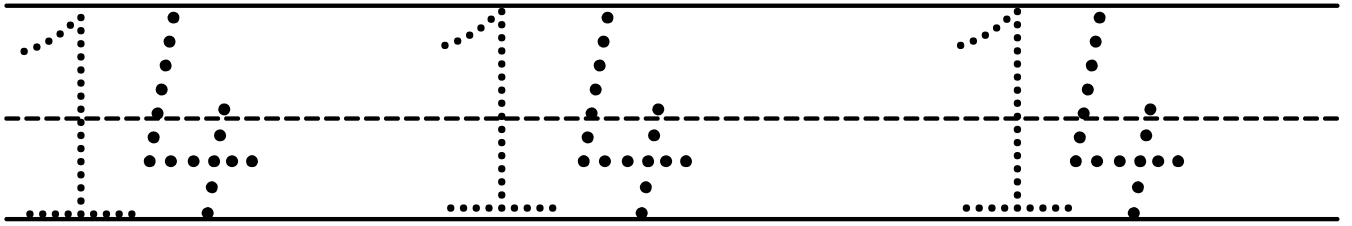
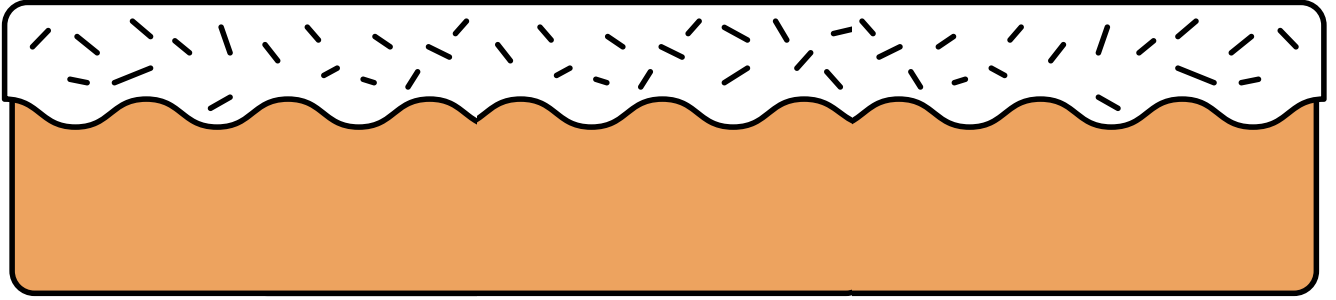

Belirtilen sayı kadar çiçeği keserek saksıya yapıştıralım.

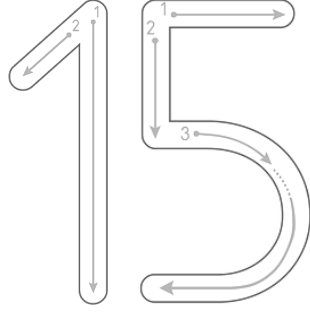

on beş

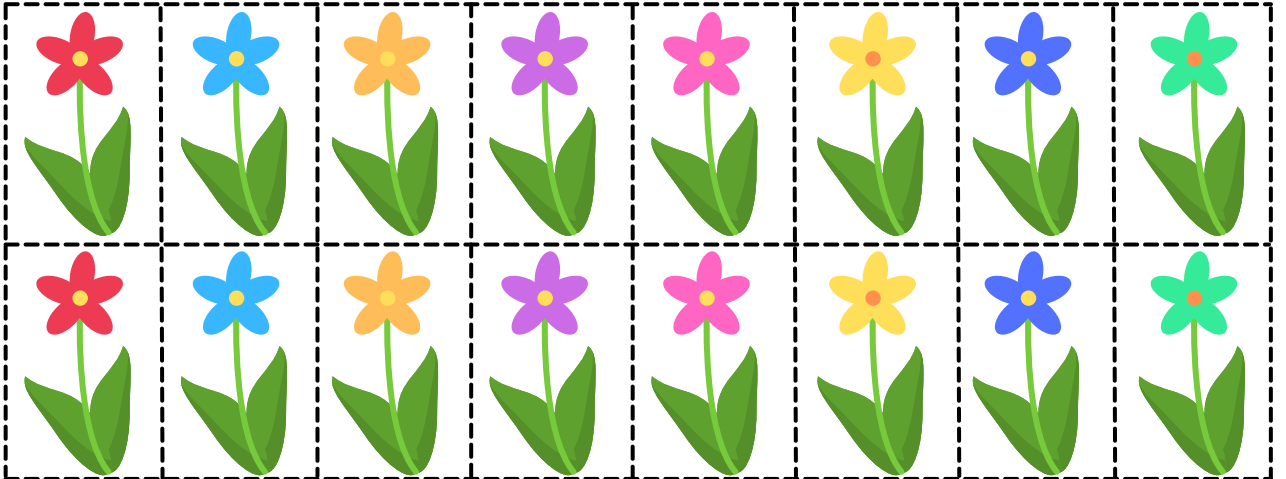
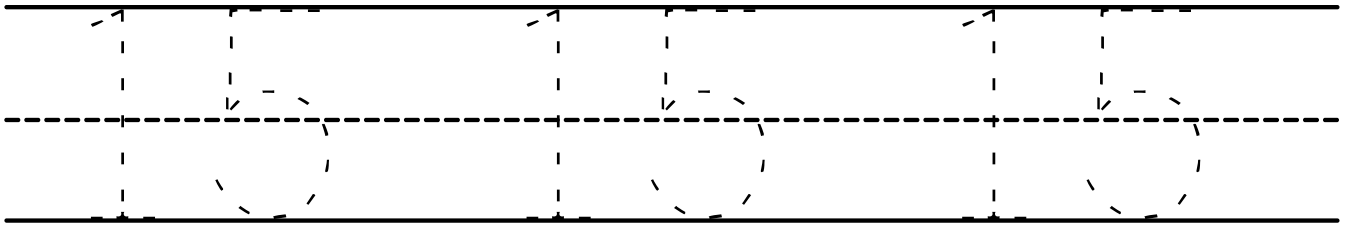

Belirtilen sayı kadar yumurtayı keserek yumurta kabına yapıştıralım.

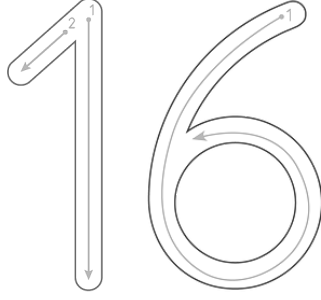

on altı

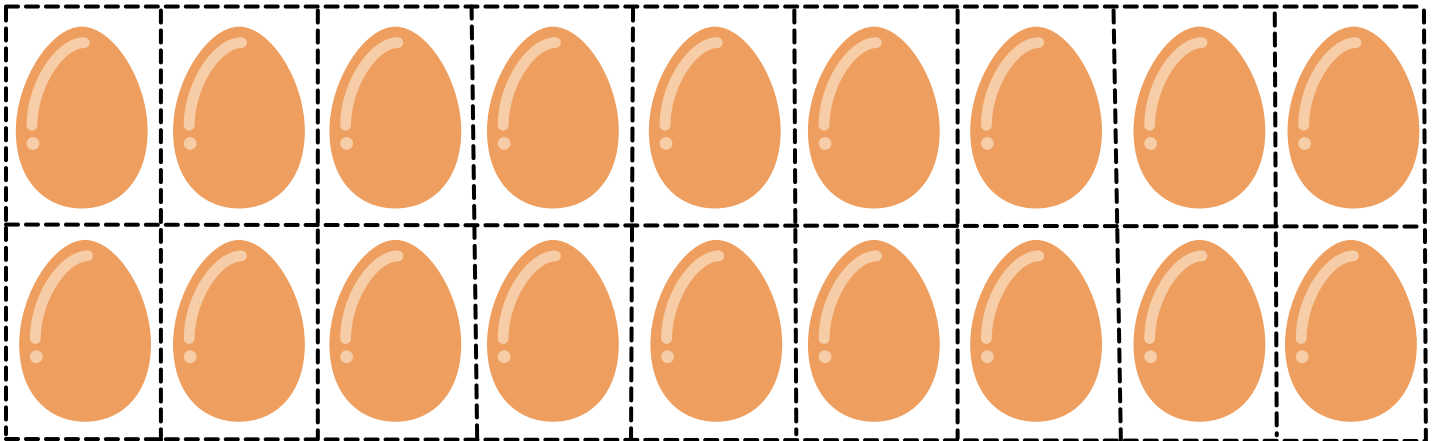
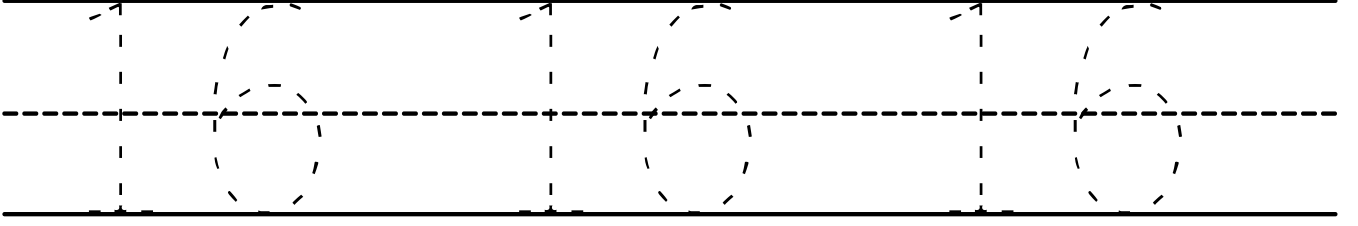

Belirtilen sayı kadar üzümü keserek salkıma yapıştıralım.

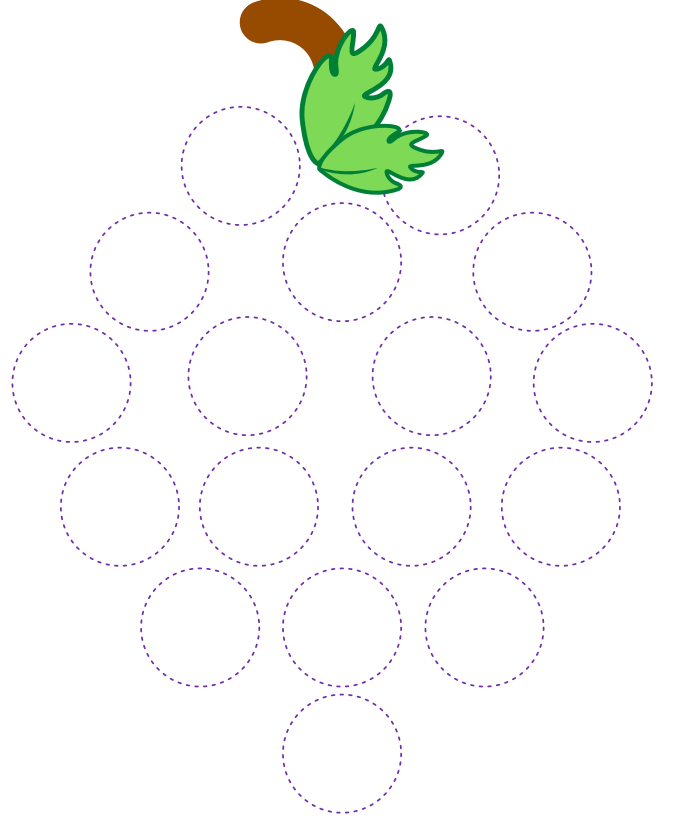
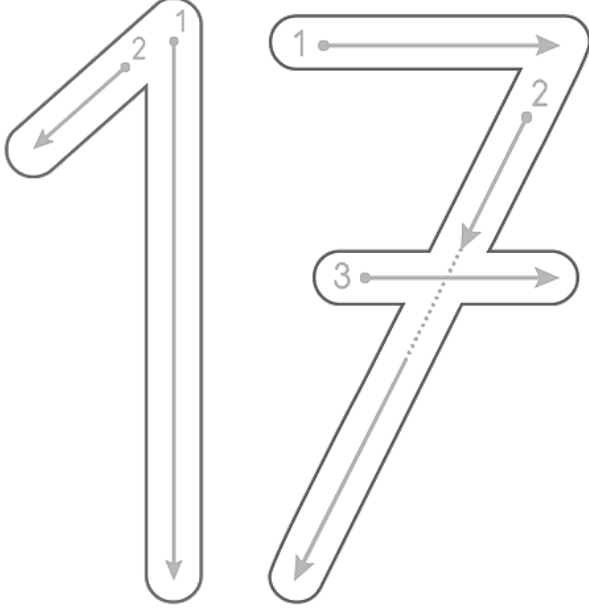

on yedi

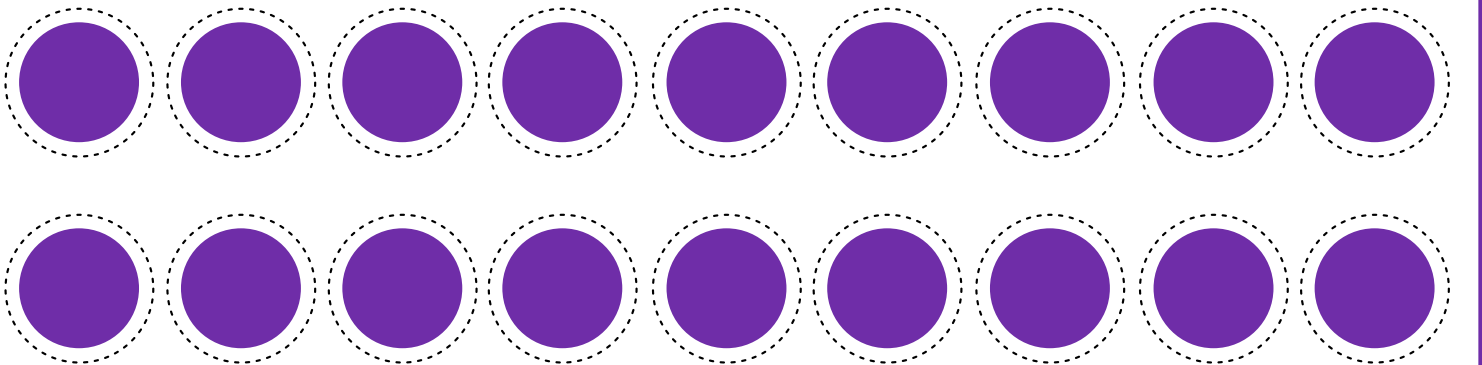
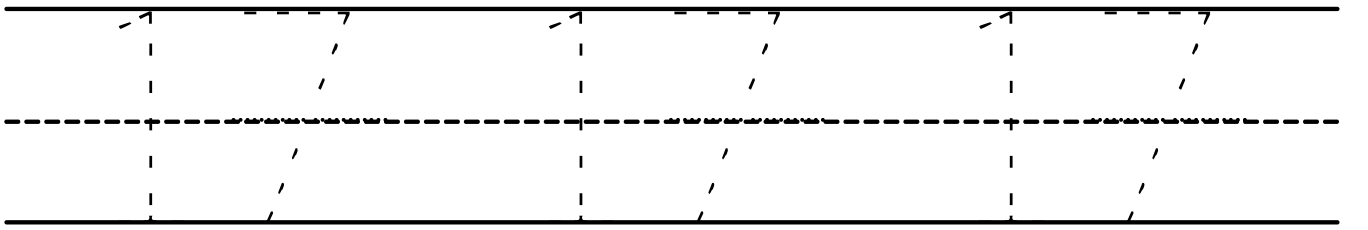

Belirtilen sayı kadar balığı keserek akvaryuma yapıştıralım.



on sekiz

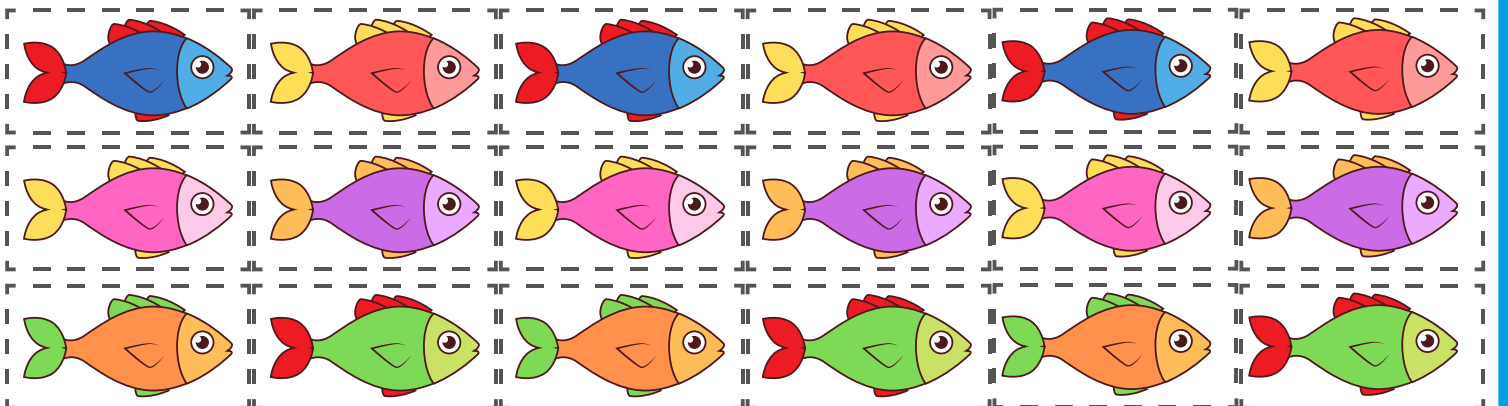
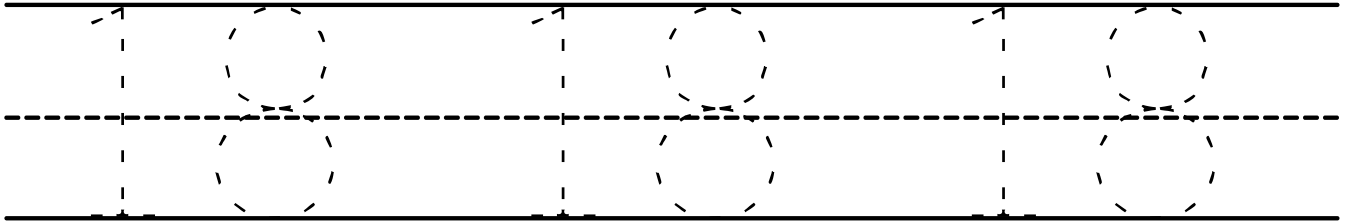
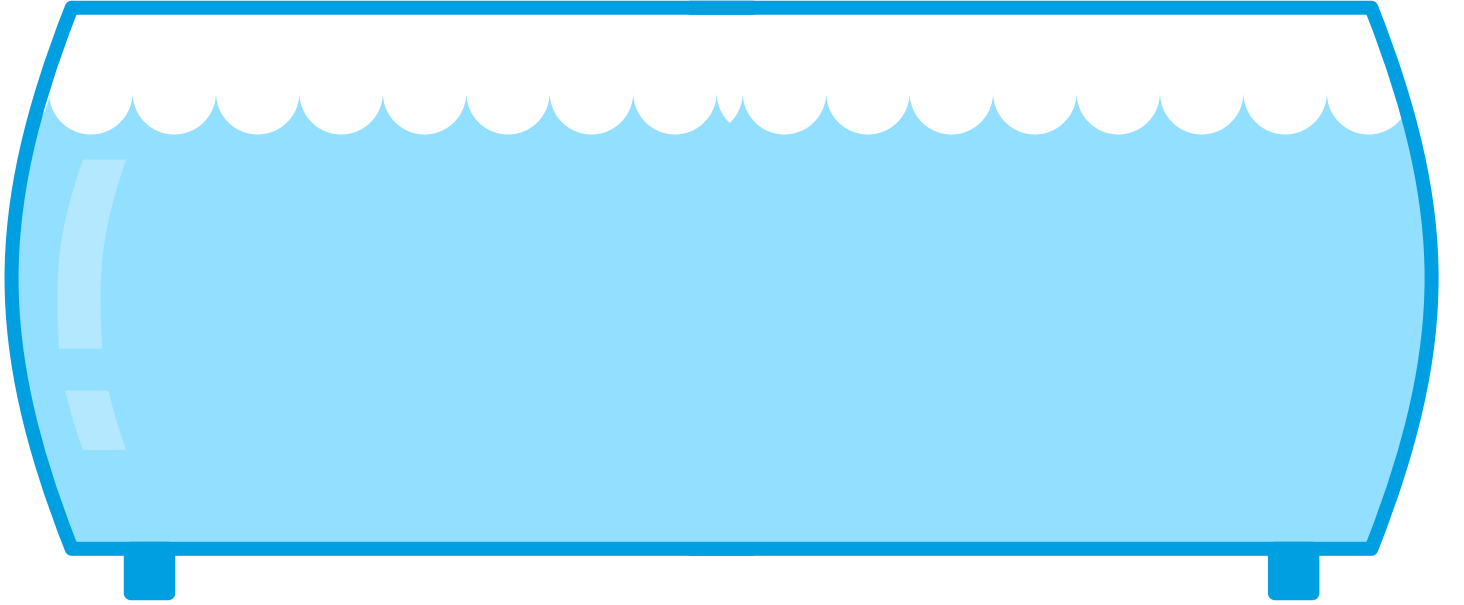

Belirtilen sayı kadar keki keserek tepsiye yapıştıralım.

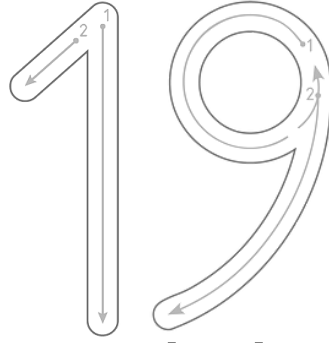

on dokuz

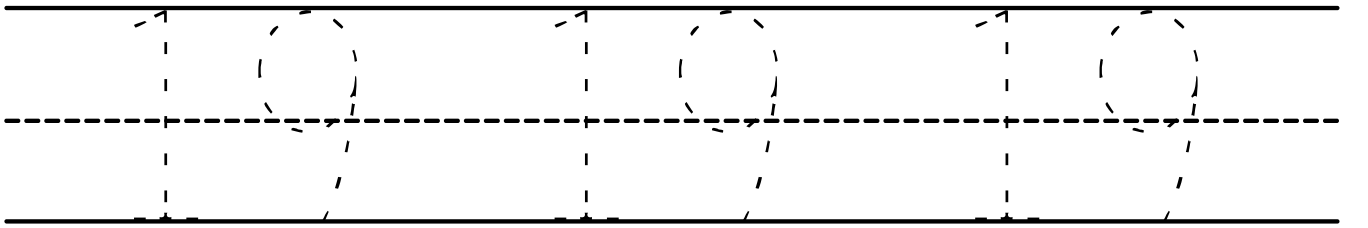
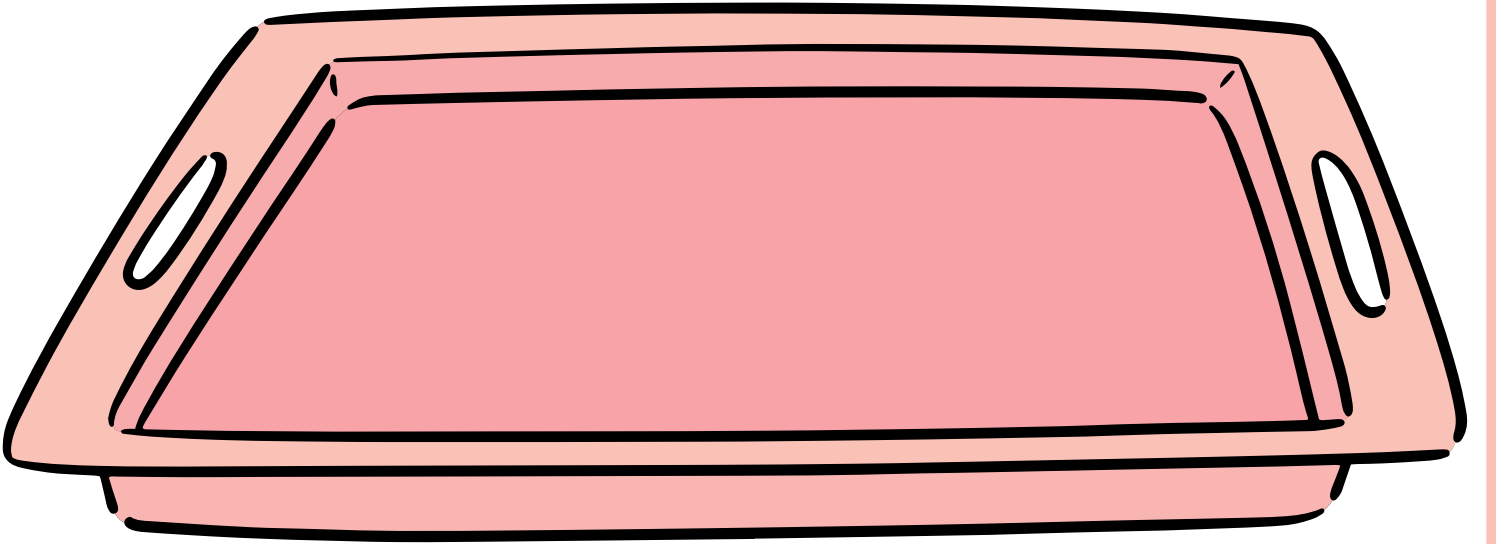

Belirtilen sayı kadar parayı keserek kumbaraya yapıştıralım.

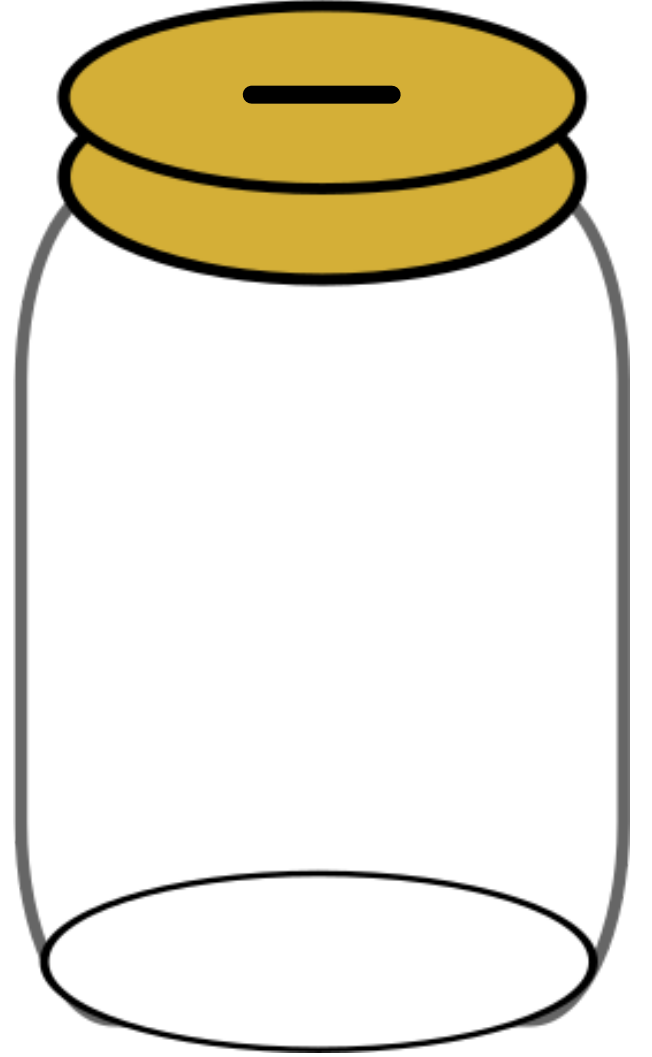
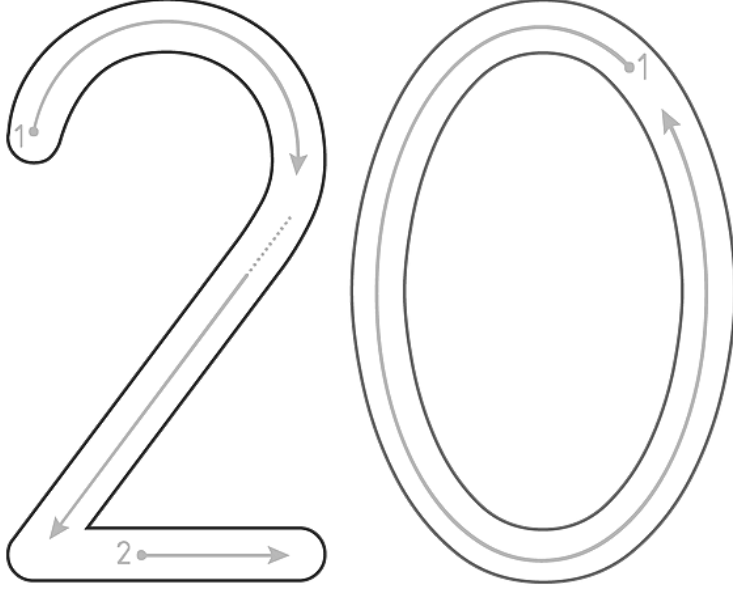

yirmi

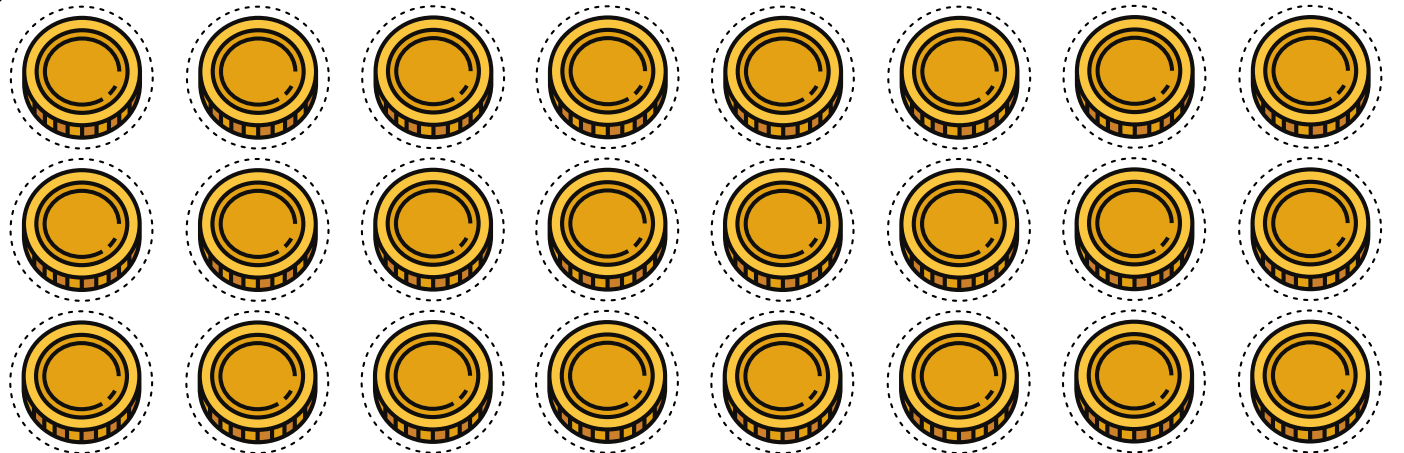
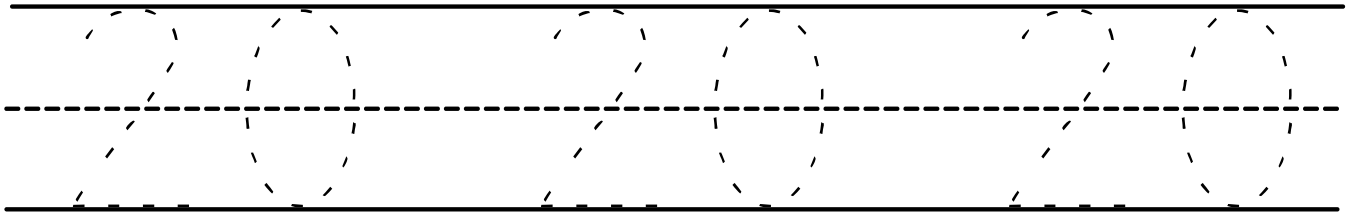

Belirtilen sayı kadar güneşi keserek bulutların üzerine yapıştıralım.

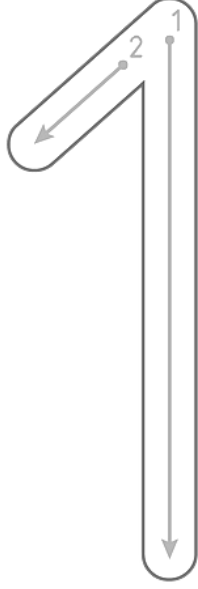

bir

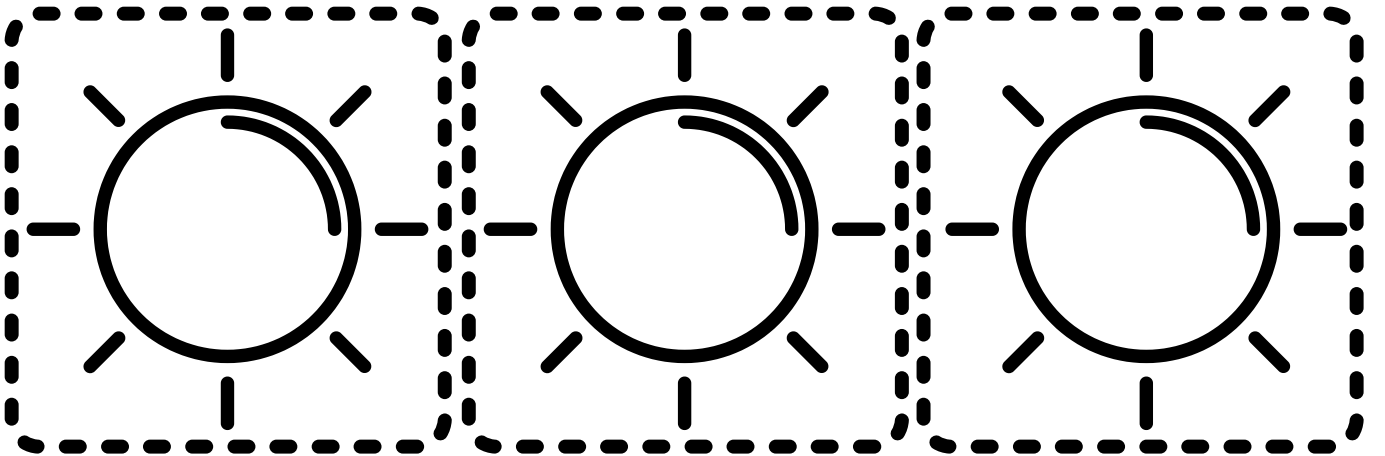
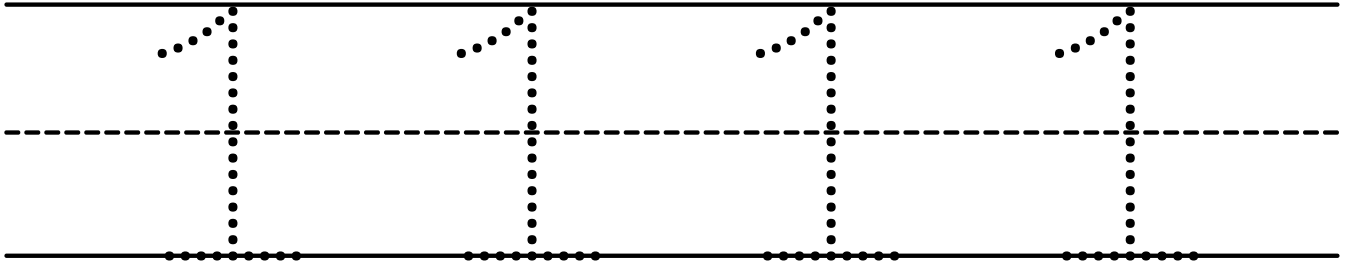

Belirtilen sayı kadar çorabı keserek askıya yapıştıralım.

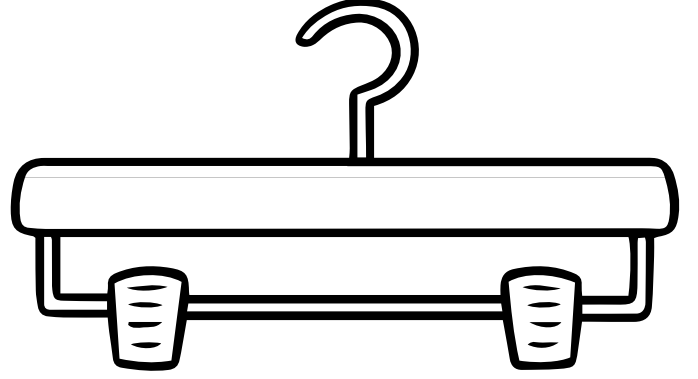
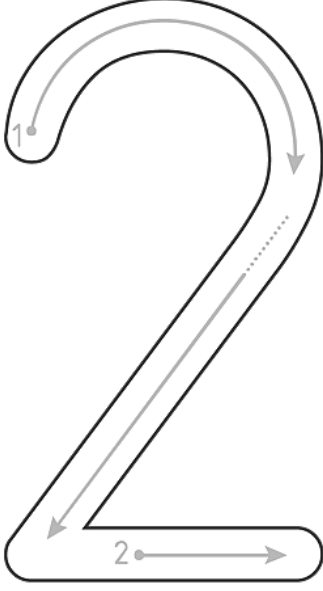

iki

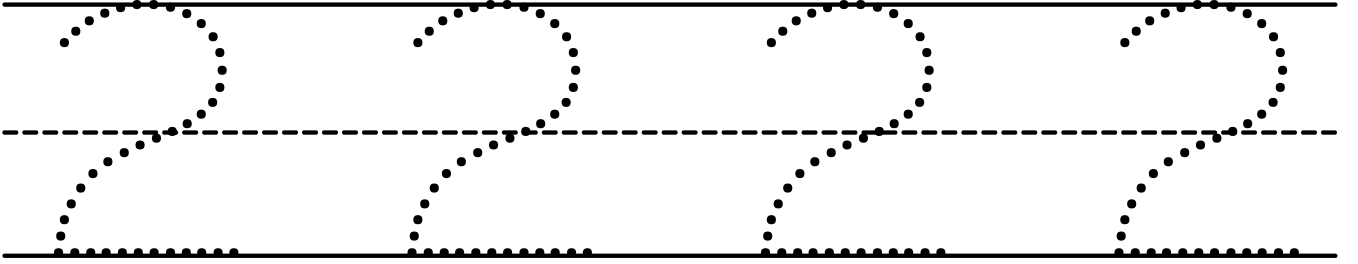

Belirtilen sayı kadar muzu keserek ağaca yapıştıralım.

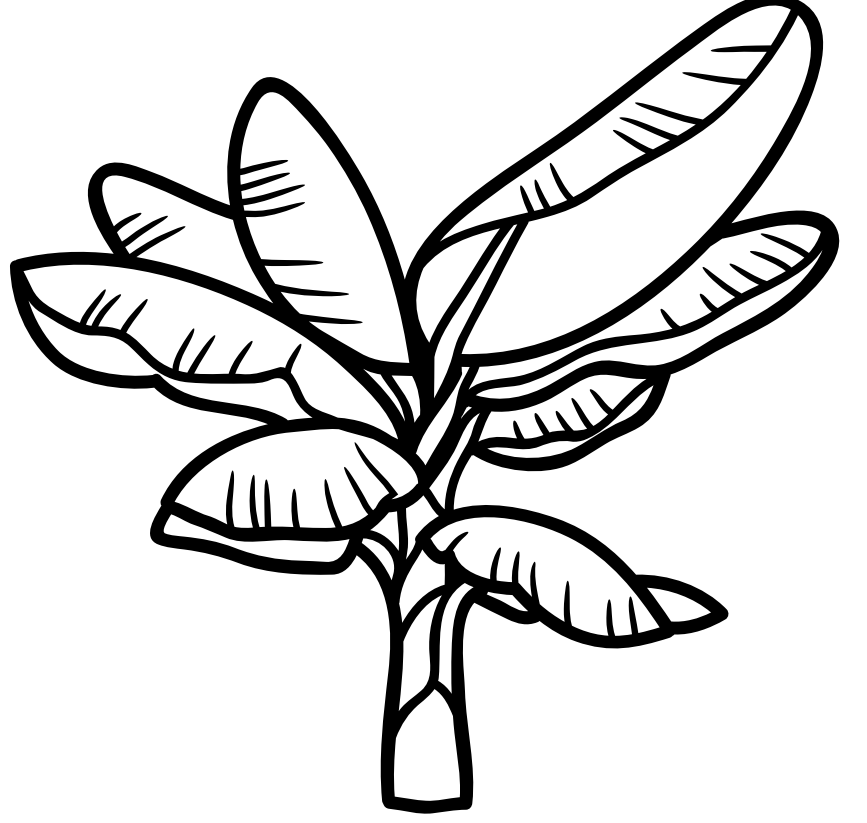
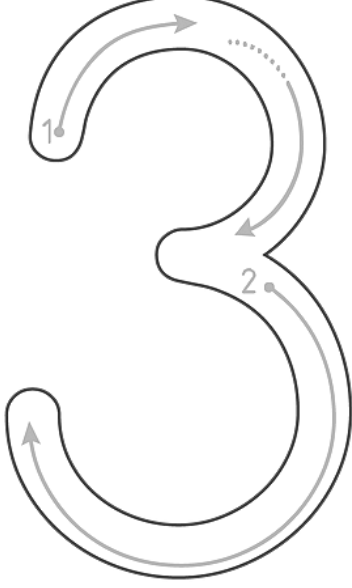

üç

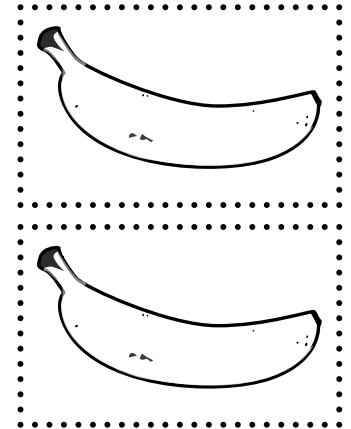
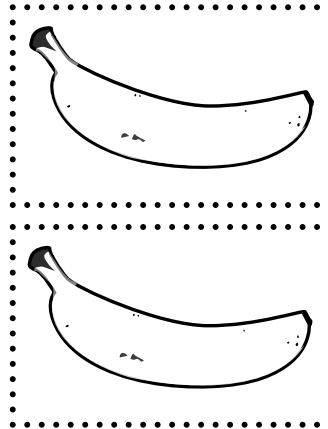
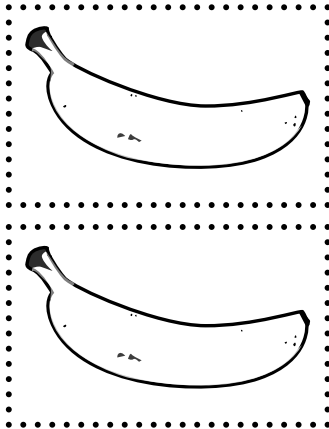
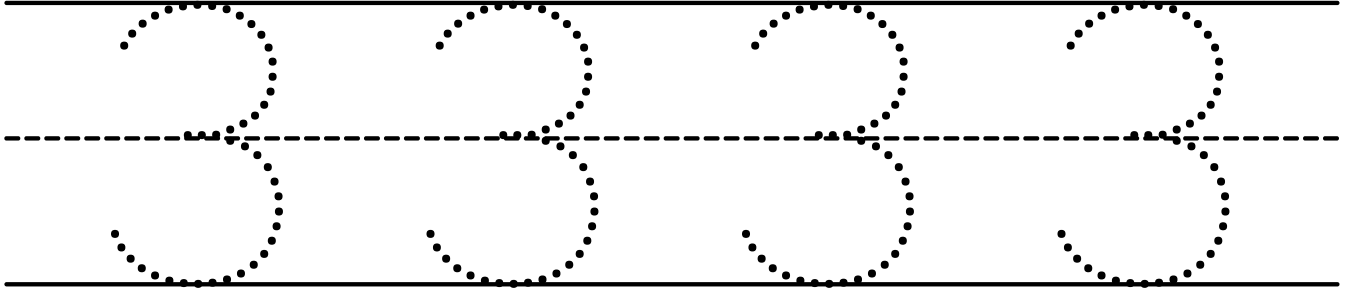

Belirtilen sayı kadar elmayı keserek ağaca yapıştıralım.

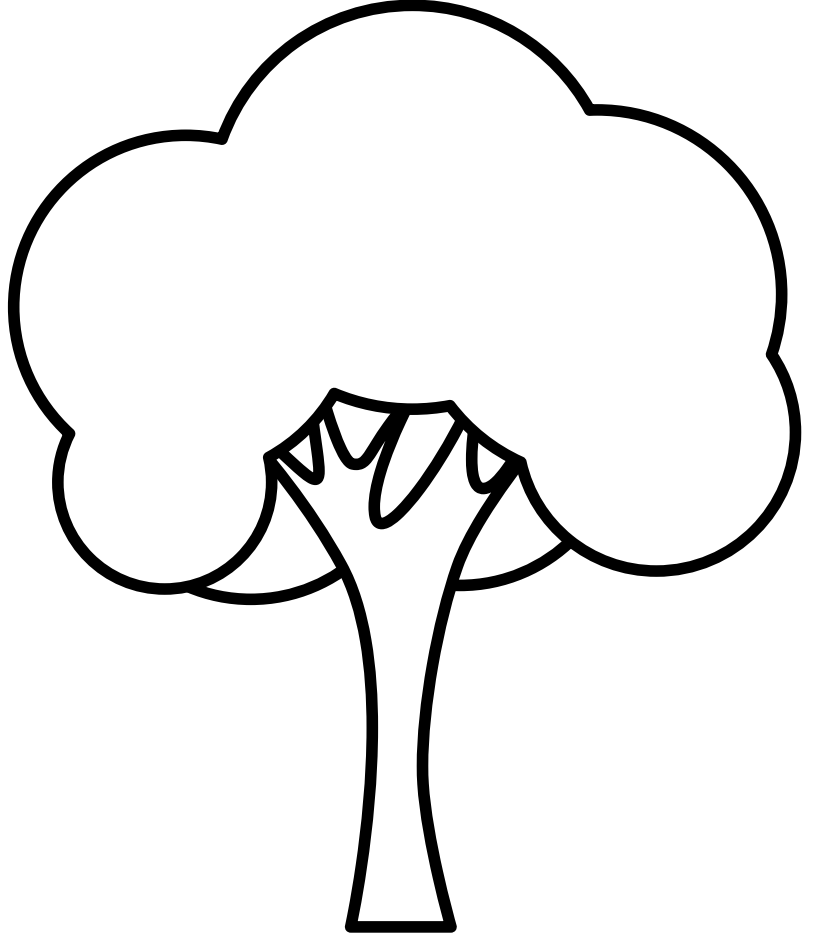
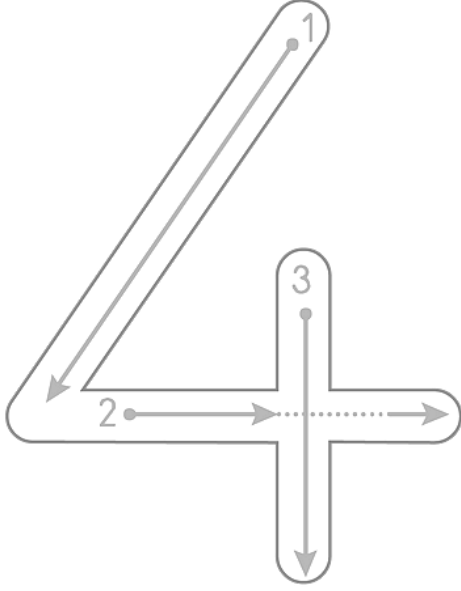

dört

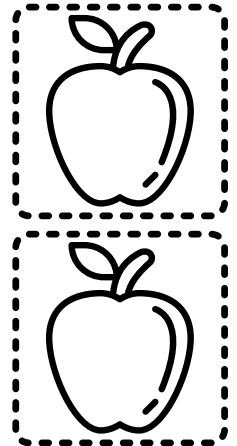
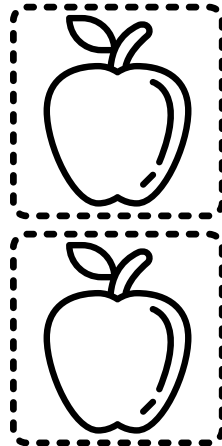
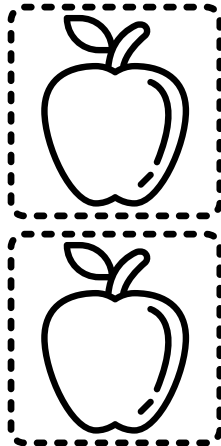
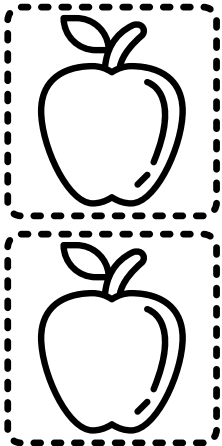
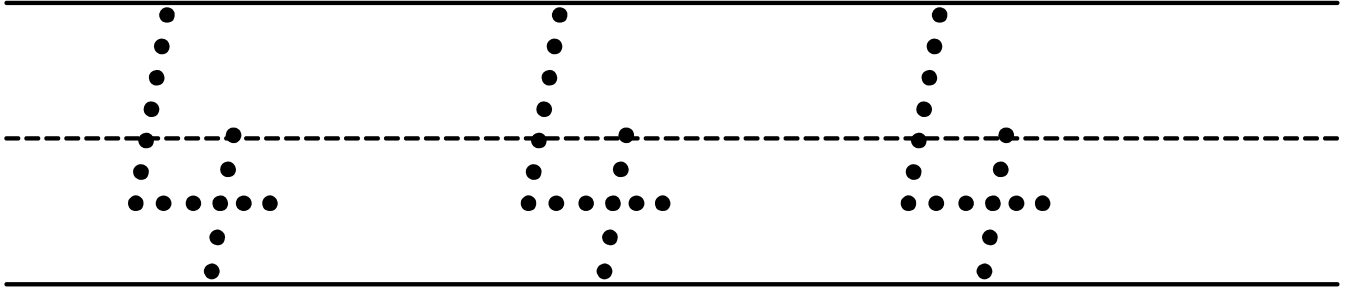

Belirtilen sayı kadar arıyı keserek kovana yapıştıralım.

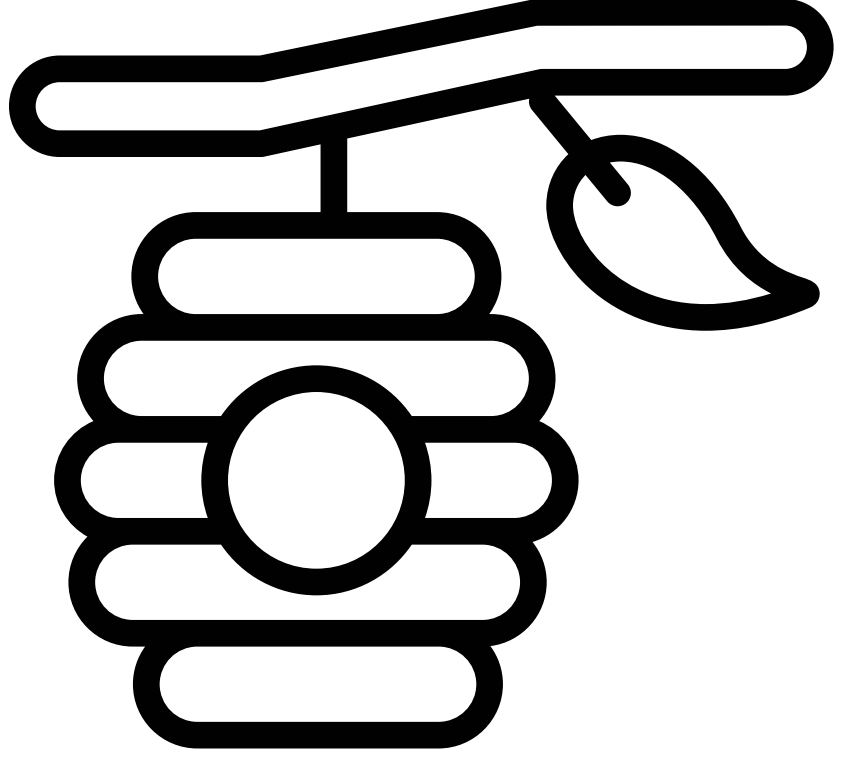
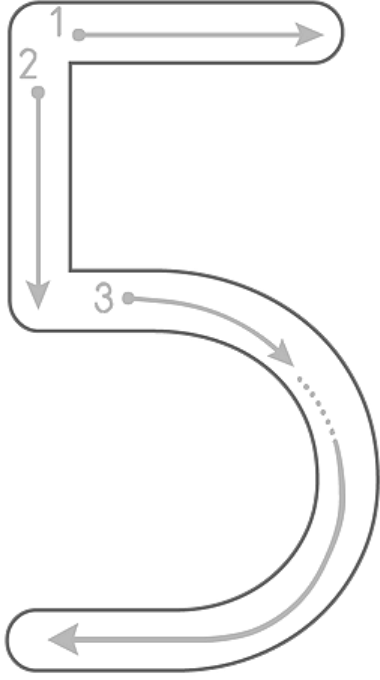

beş

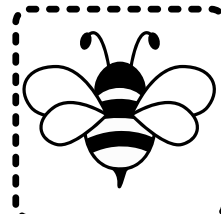
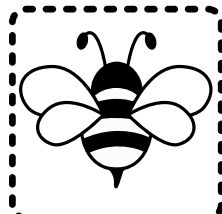
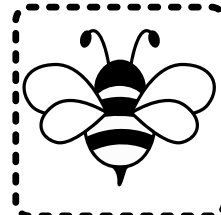
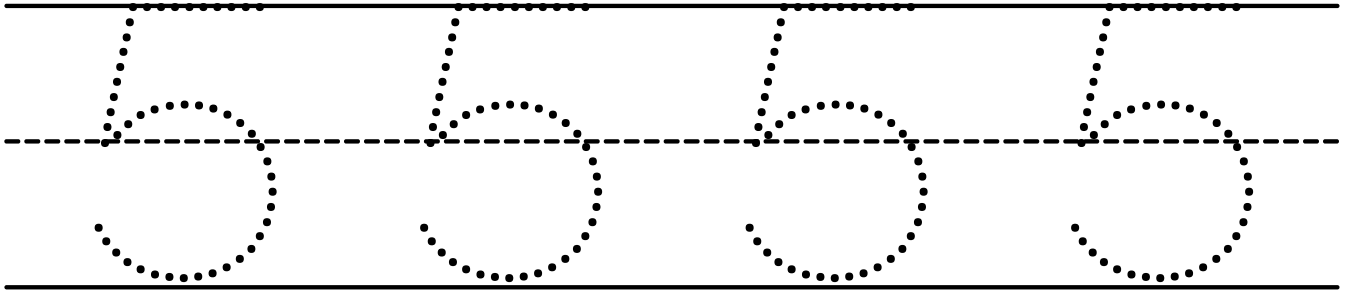

Belirtilen sayı kadar kelebeği keserek bitkinin etrafına yapıştıralım.

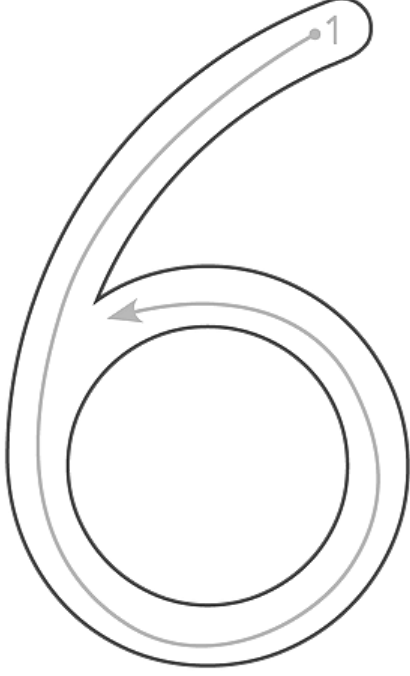

altı

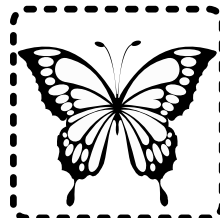
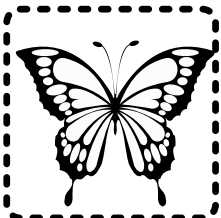
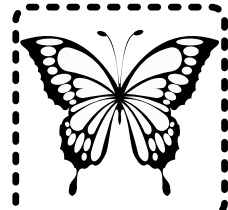
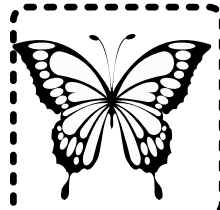
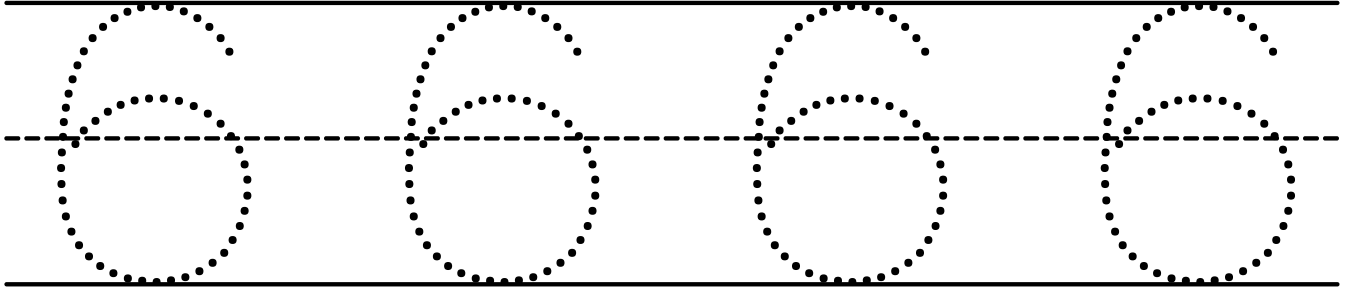
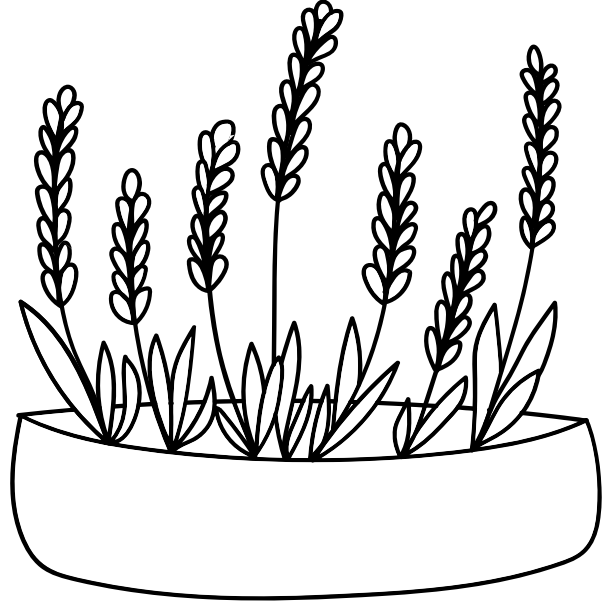

Belirtilen sayı kadar pizza dilimini keserek tabağa yapıştıralım.

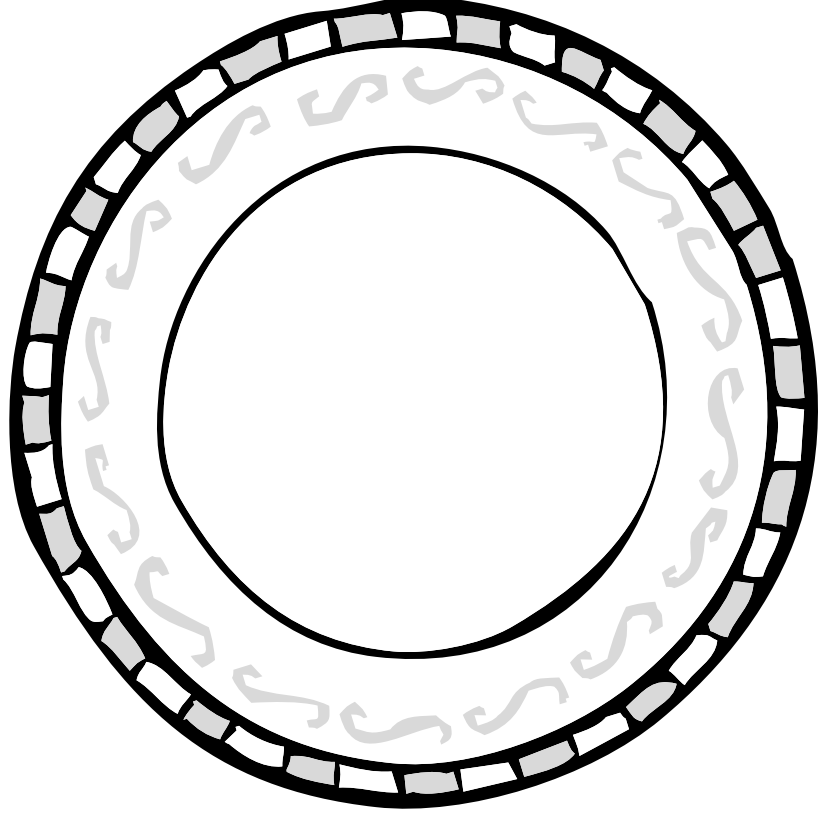
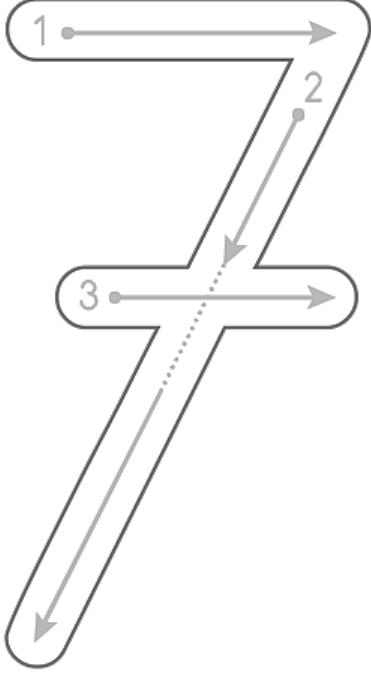

yedi

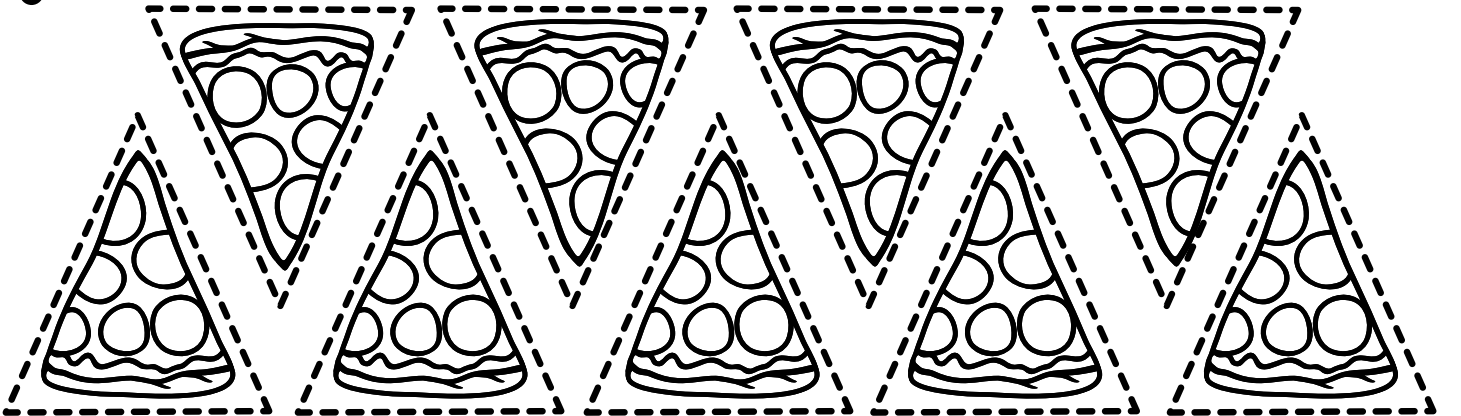
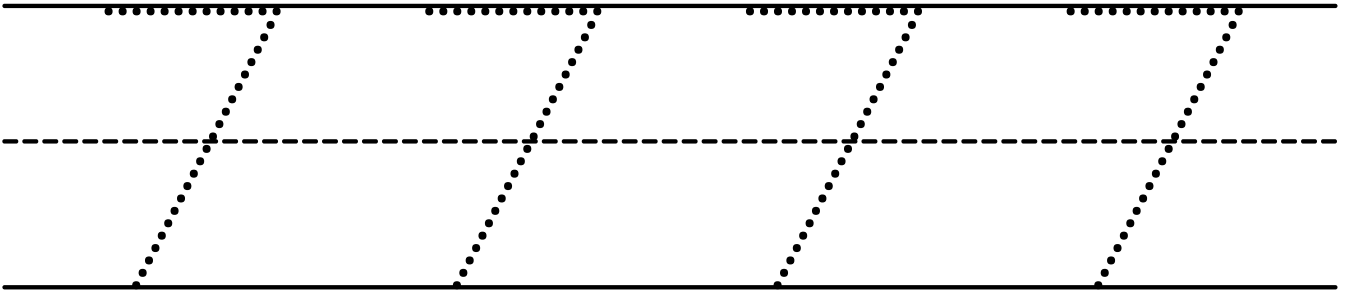

Belirtilen sayı kadar çileği keserek sepete yapıştıralım.

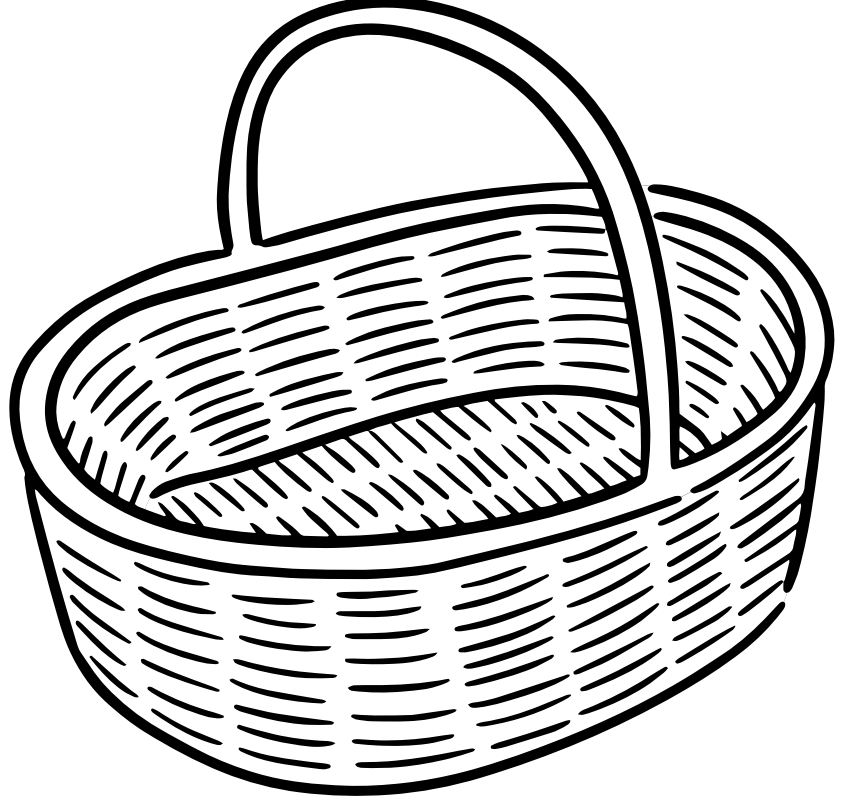
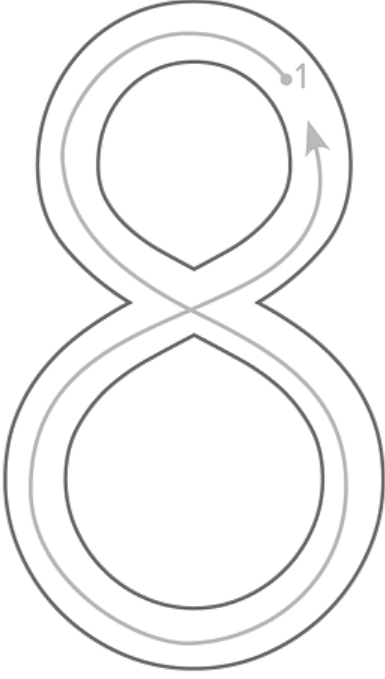

sekiz

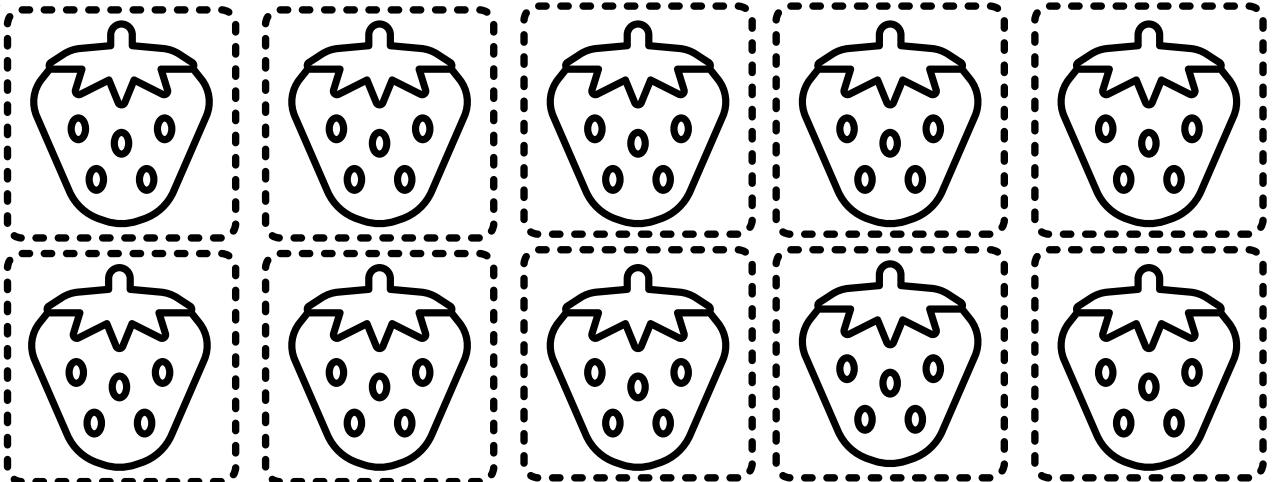
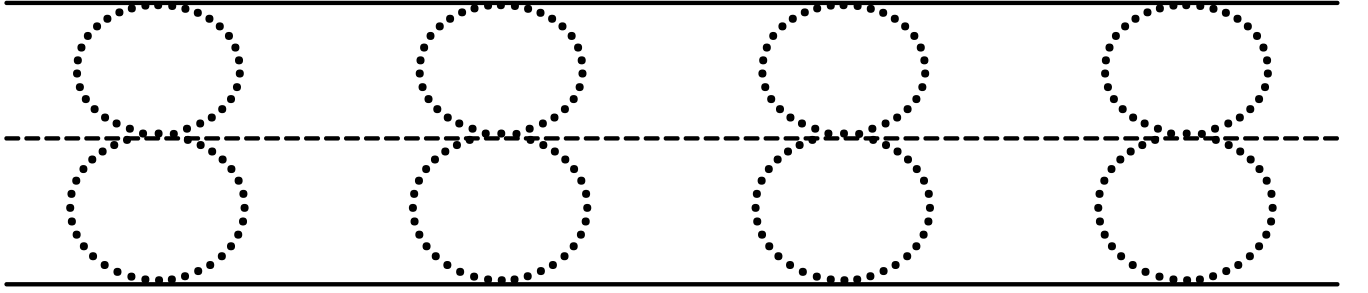

Belirtilen sayı kadar portakalı keserek ağaca yapıştıralım.

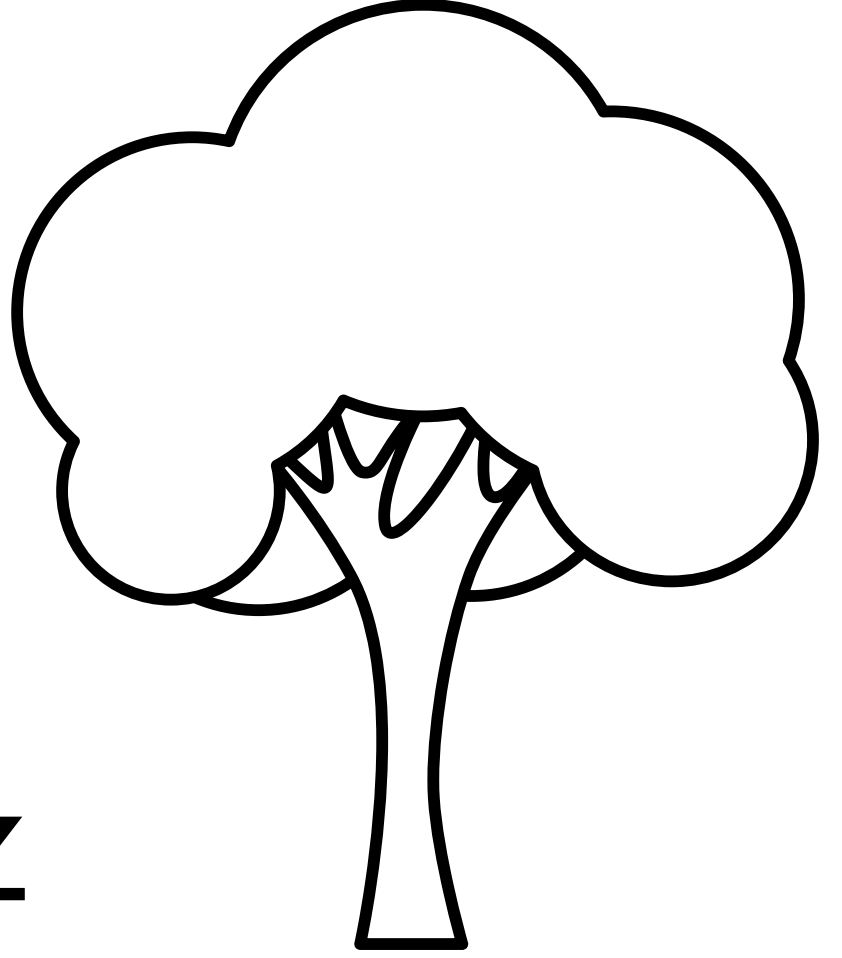
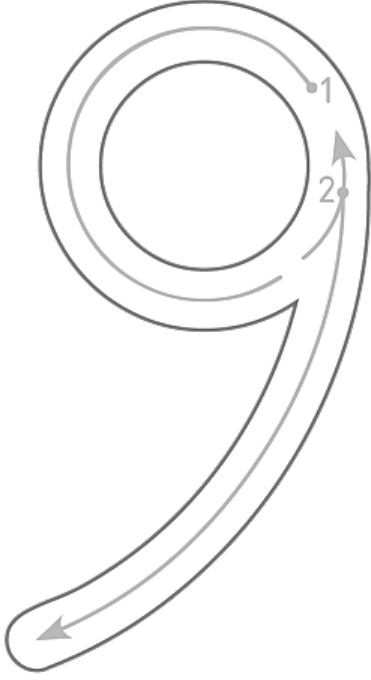

dokuz

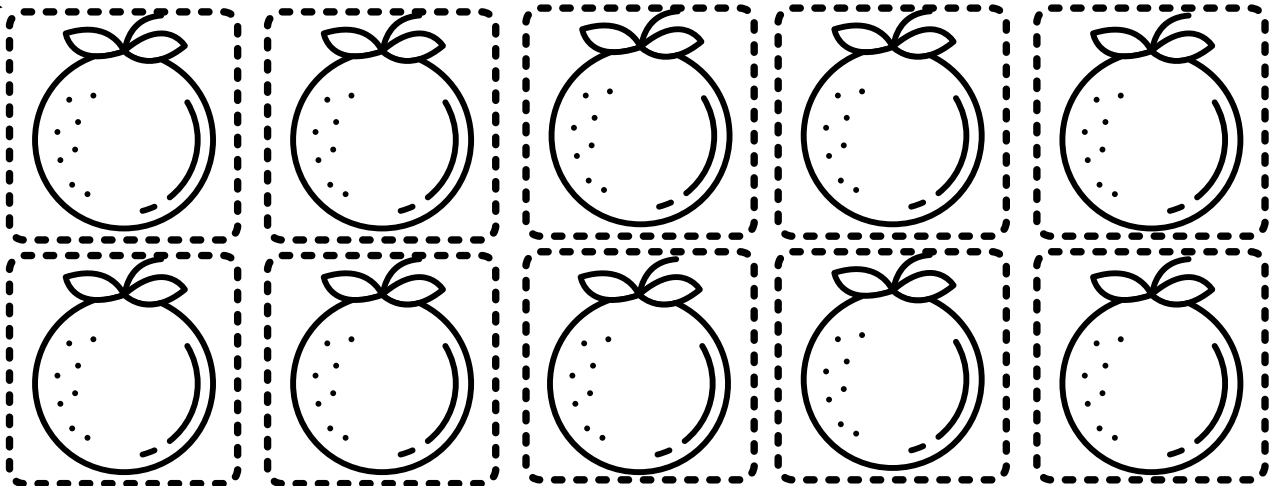
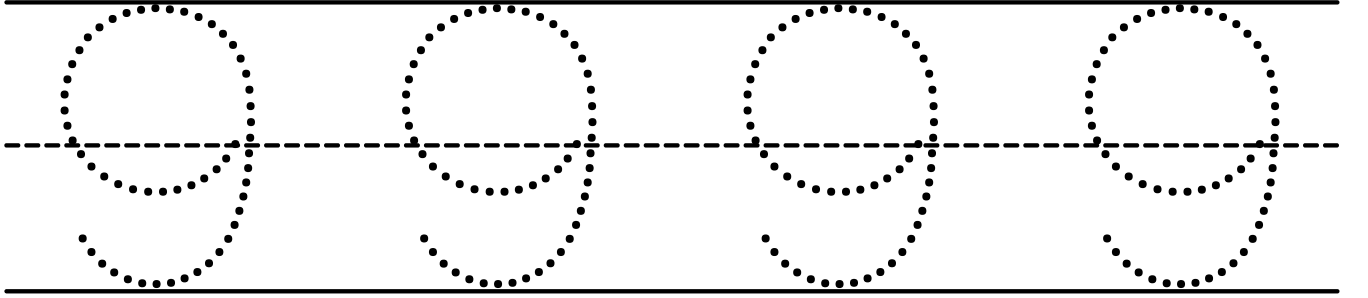

Belirtilen sayı kadar kurabiyeyi keserek kavanoza yapıştıralım.

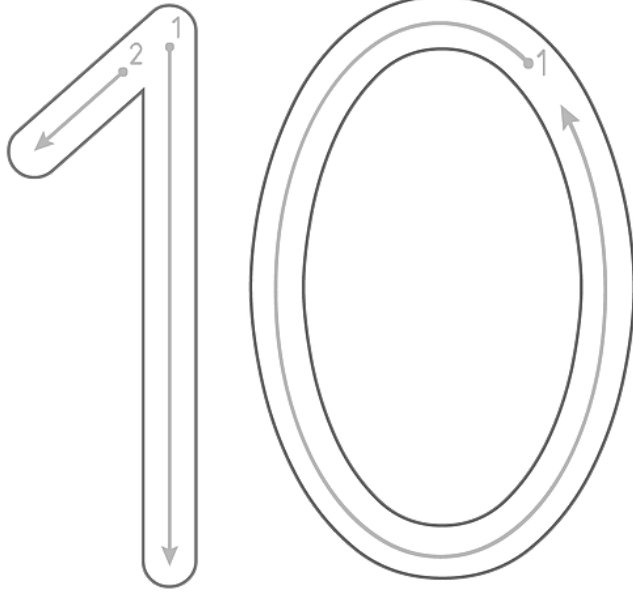

on

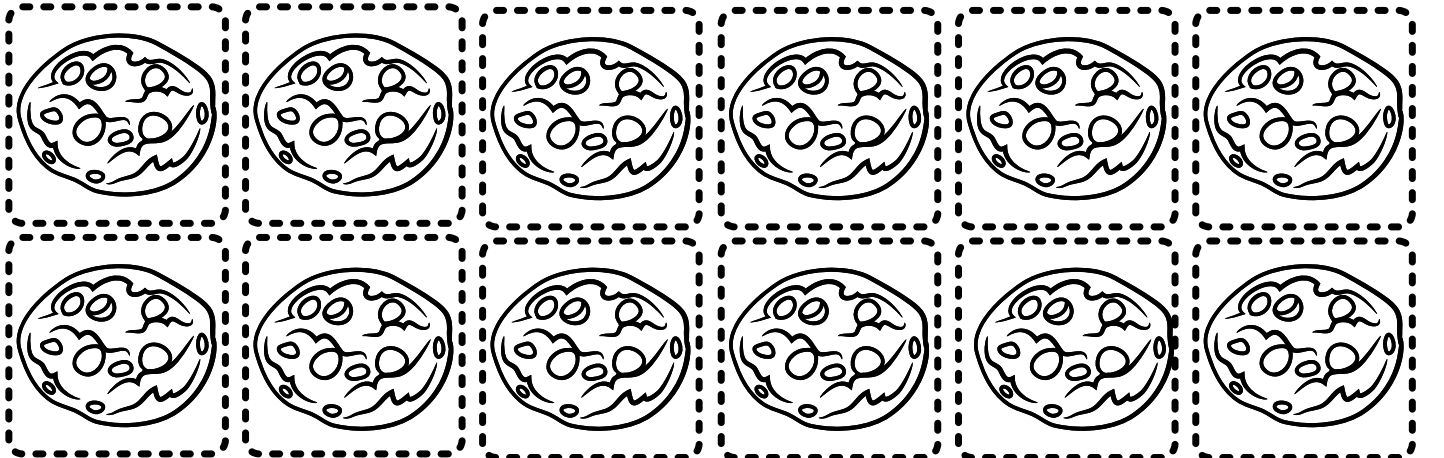
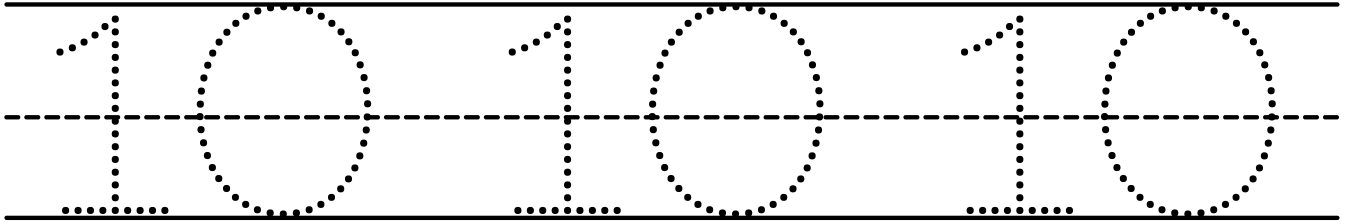

Belirtilen sayı kadar kalp şeklini keserek kavanozun içine yapıştıralım.

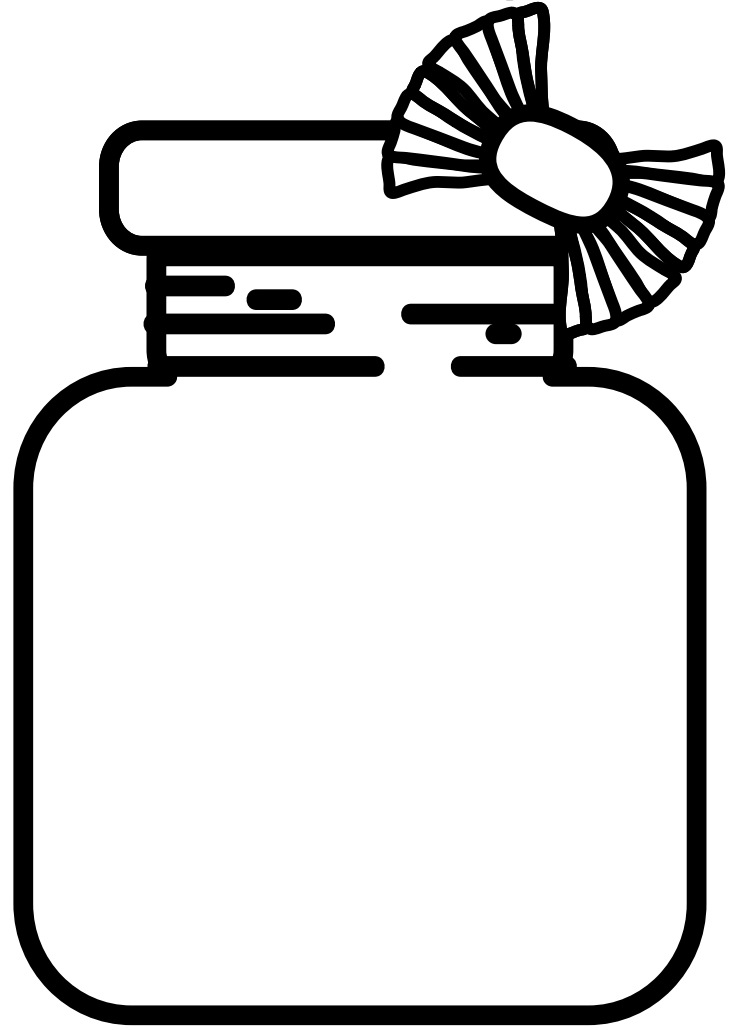
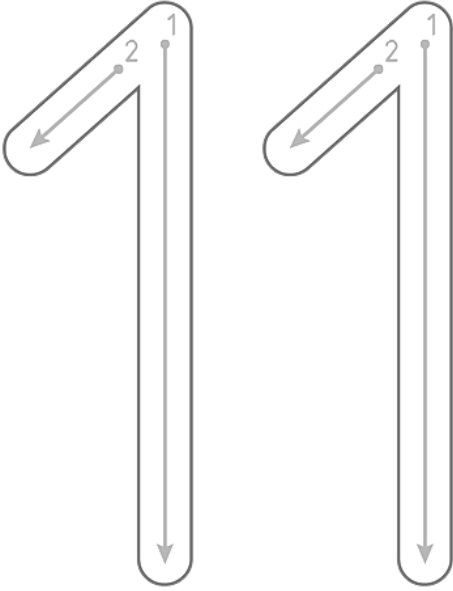

on bir

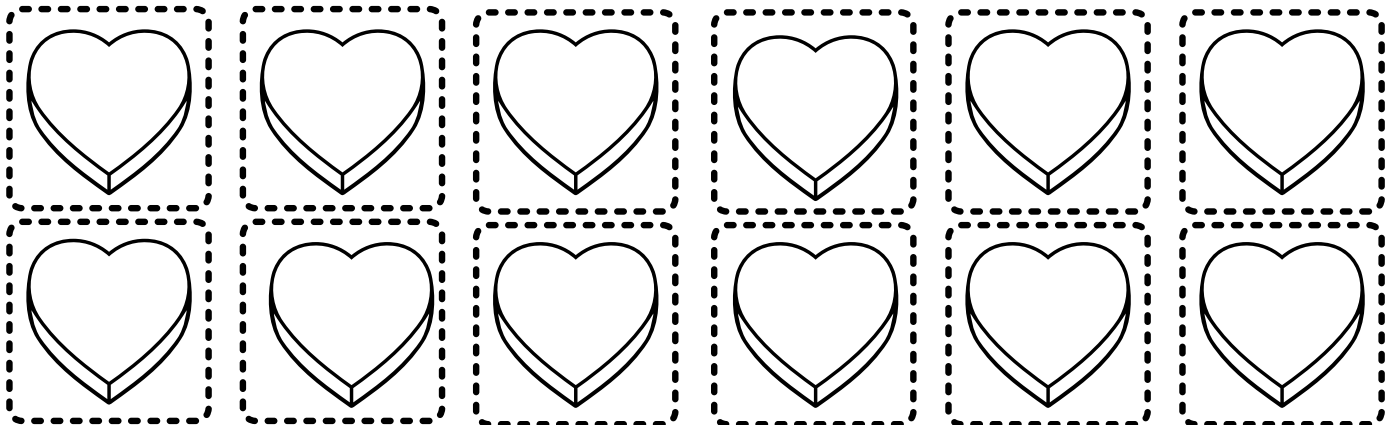
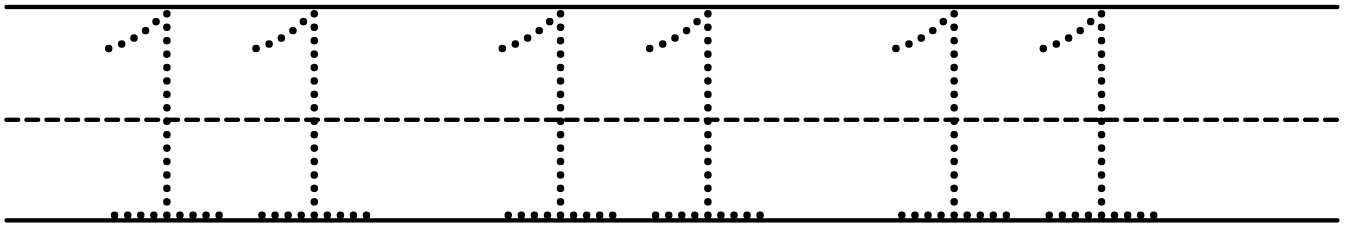

Belirtilen sayı kadar çiçeği keserek bukete yapıştıralım.

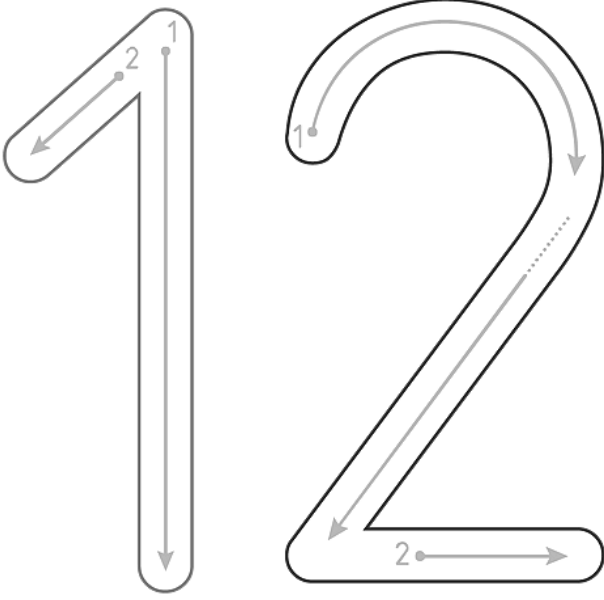

on iki

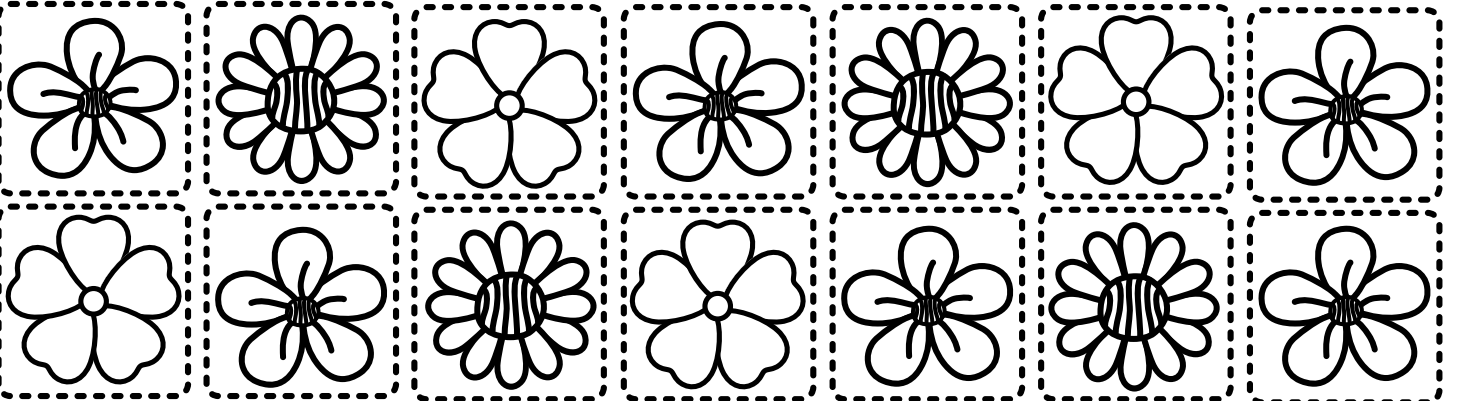
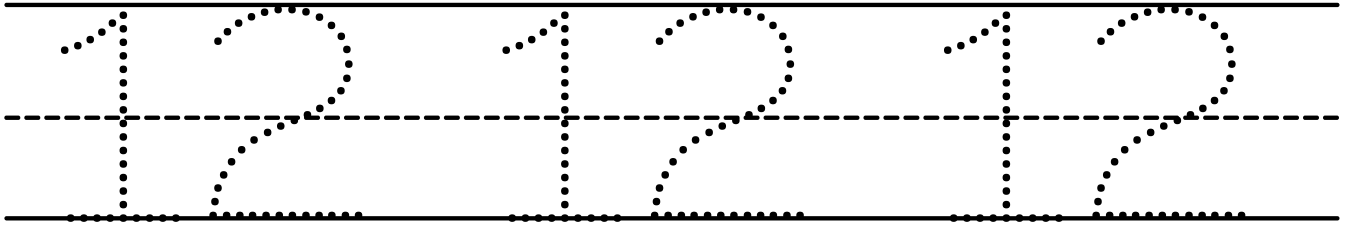

Belirtilen sayı kadar çikolatayı keserek çikolata kutusuna yapıştıralım.



on üç

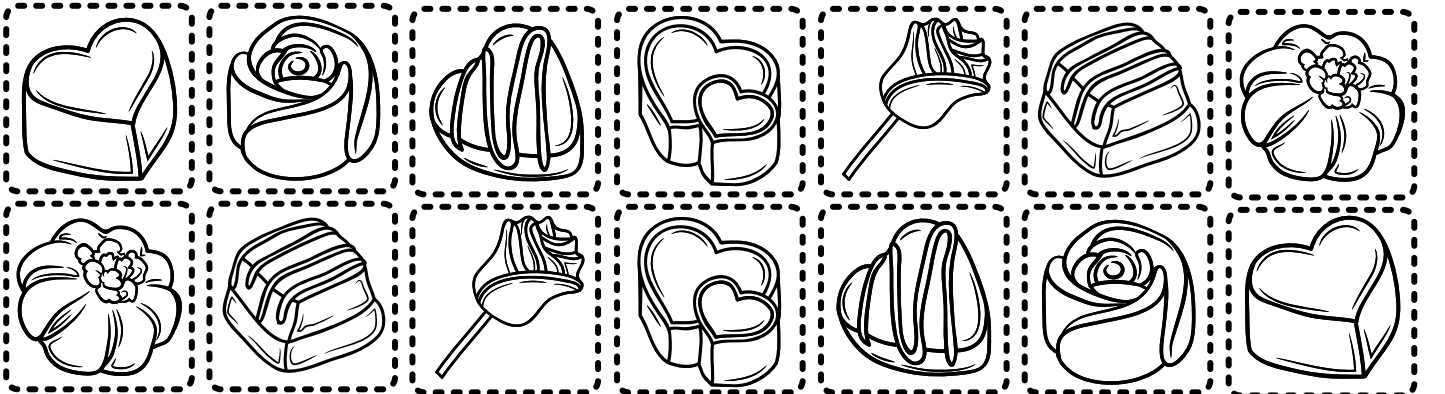
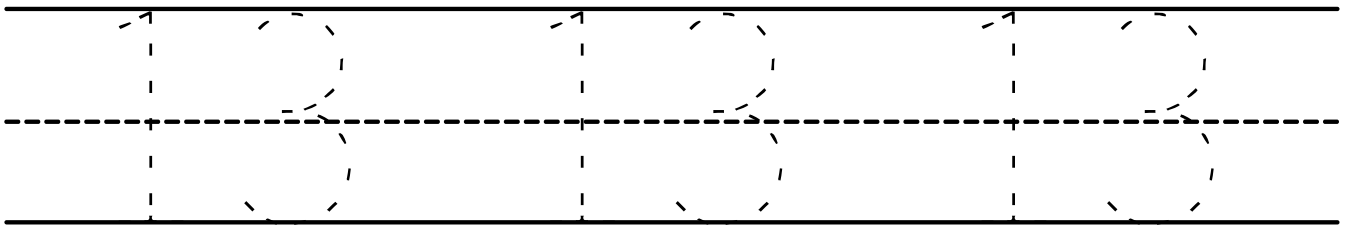
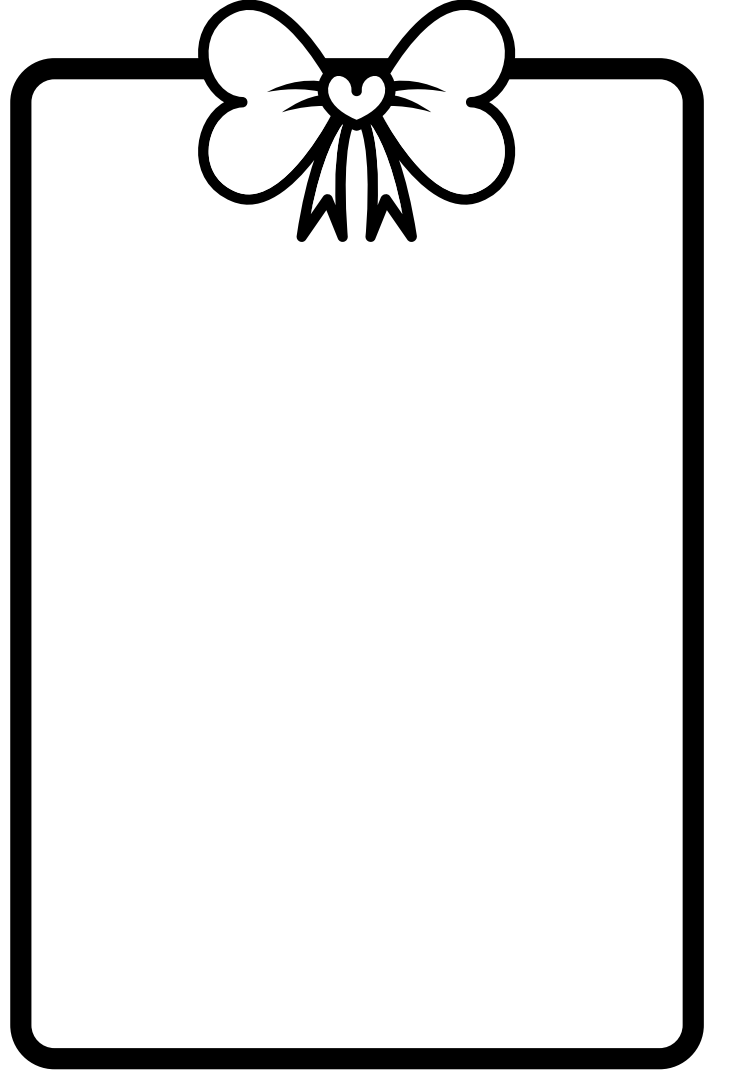

Belirtilen sayı kadar mumu keserek pastaya yapıştıralım.

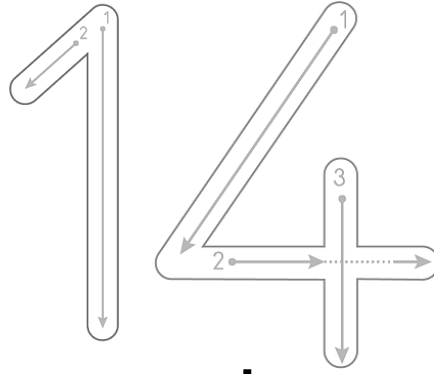

on dört

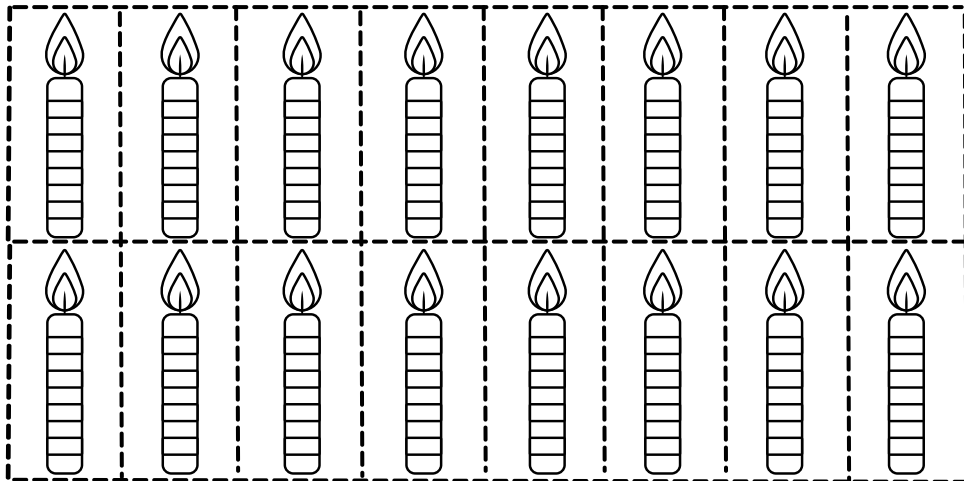
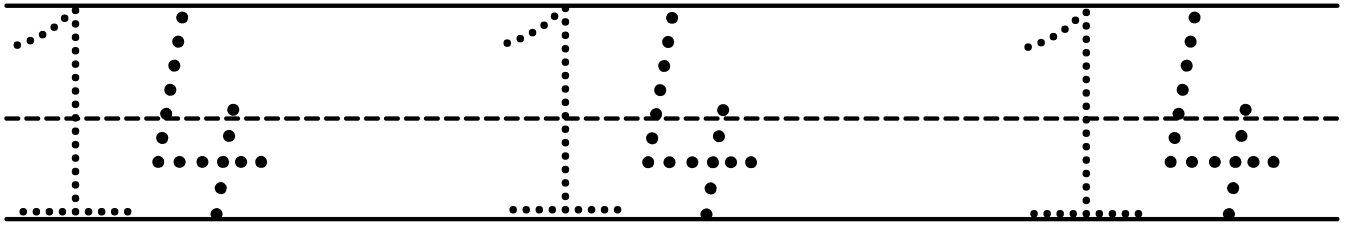
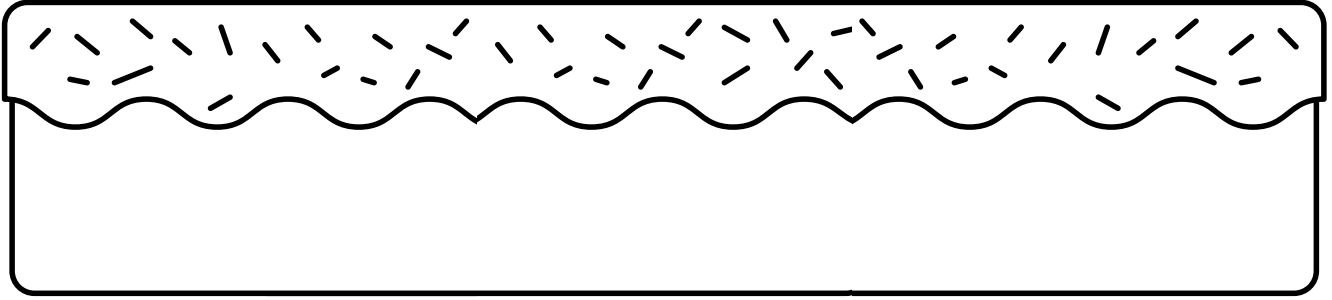

Belirtilen sayı kadar çiçeği keserek saksıya yapıştıralım.

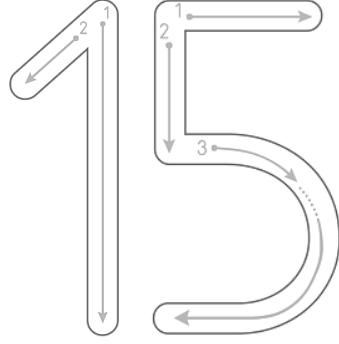

on beş

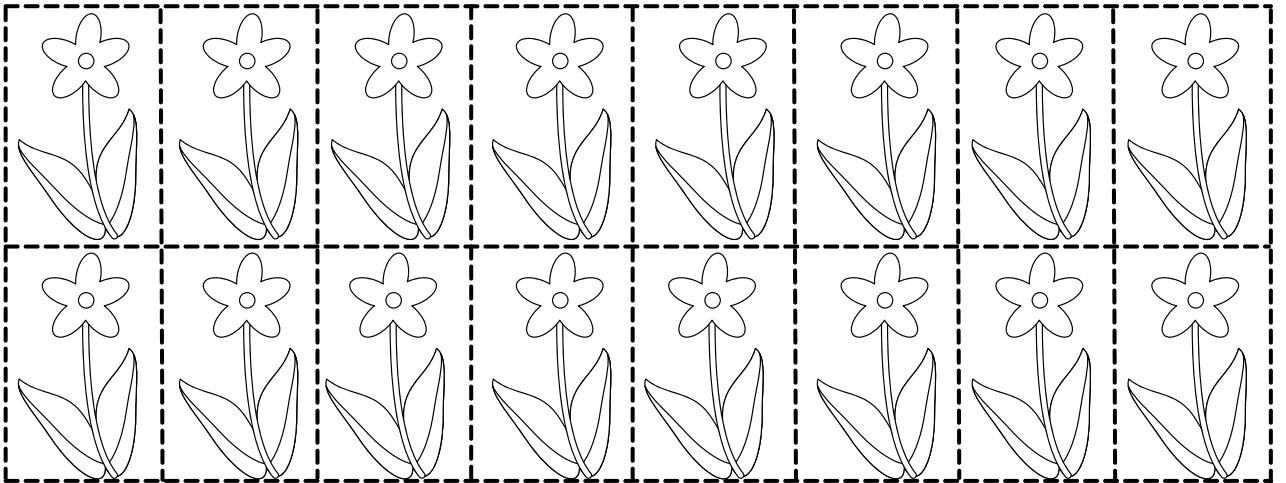
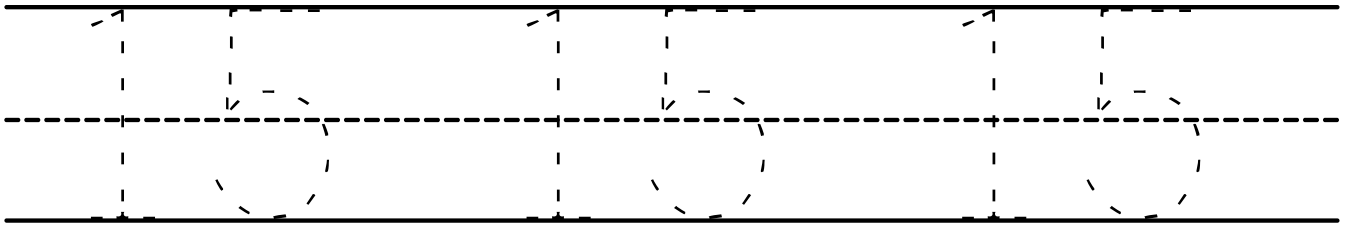
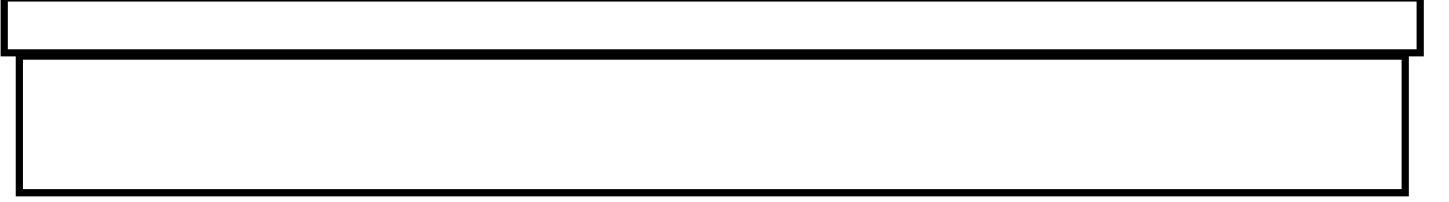

Belirtilen sayı kadar yumurtayı keserek yumurta kabına yapıştıralım.

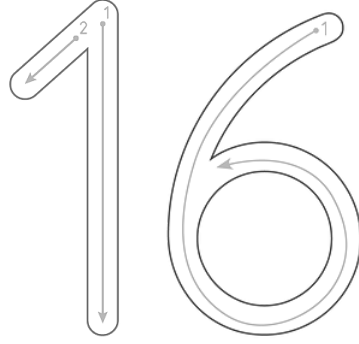

on altı

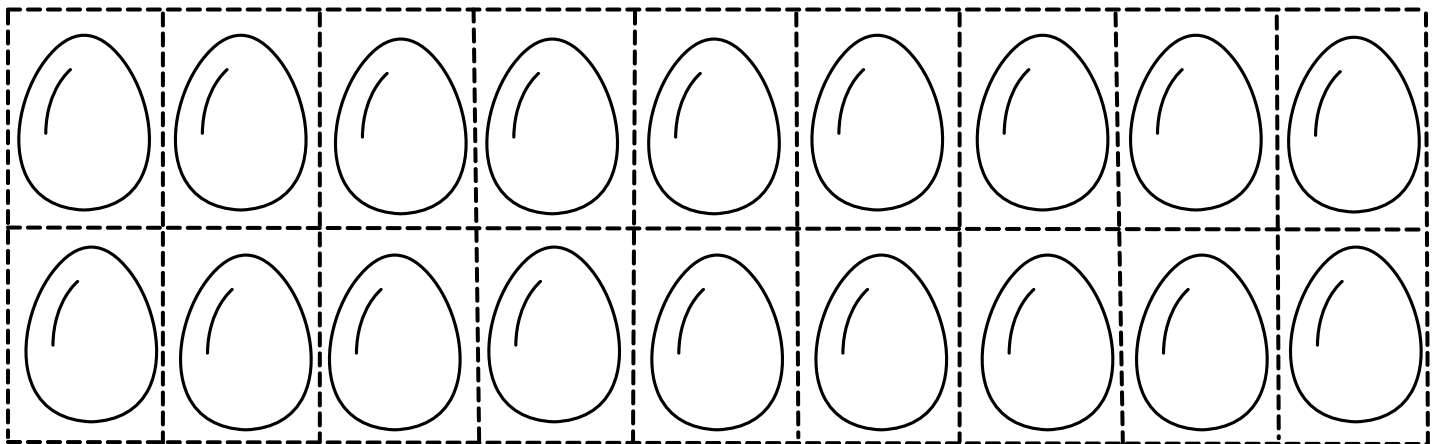
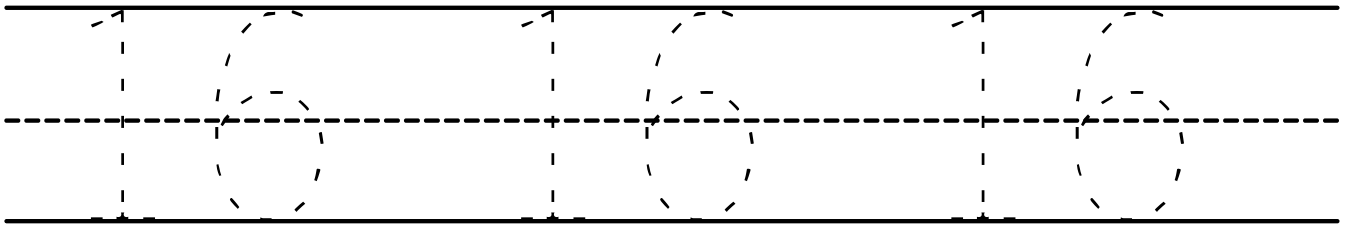

Belirtilen sayı kadar üzümü keserek salkıma yapıştıralım.

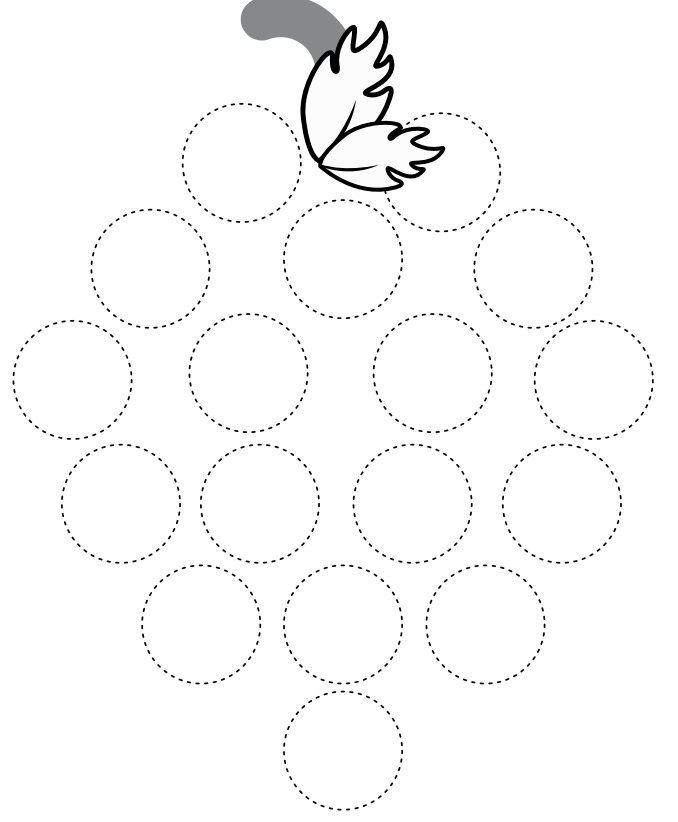
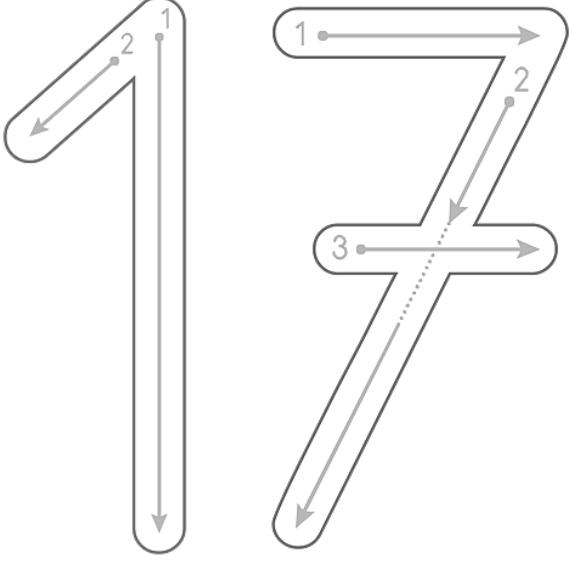

on yedi

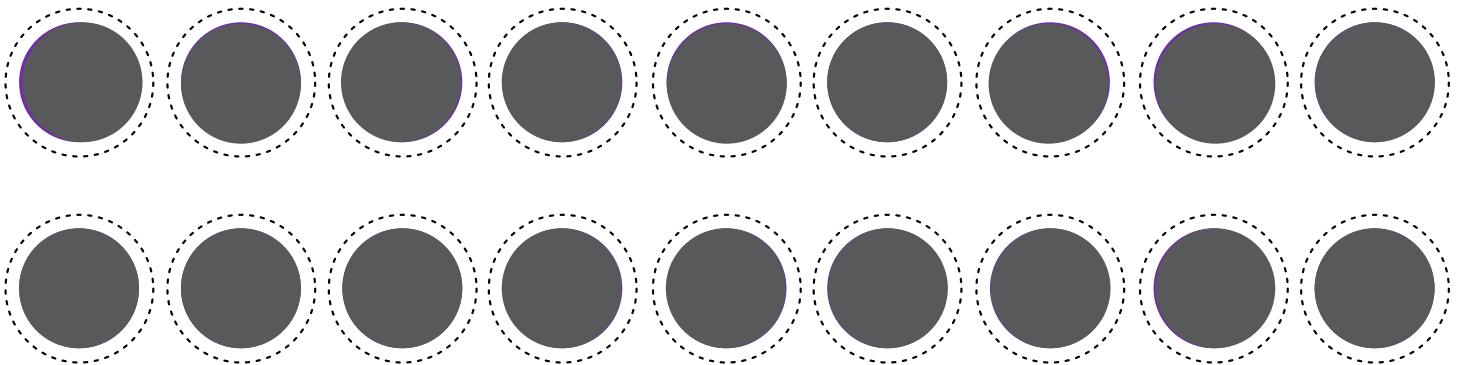
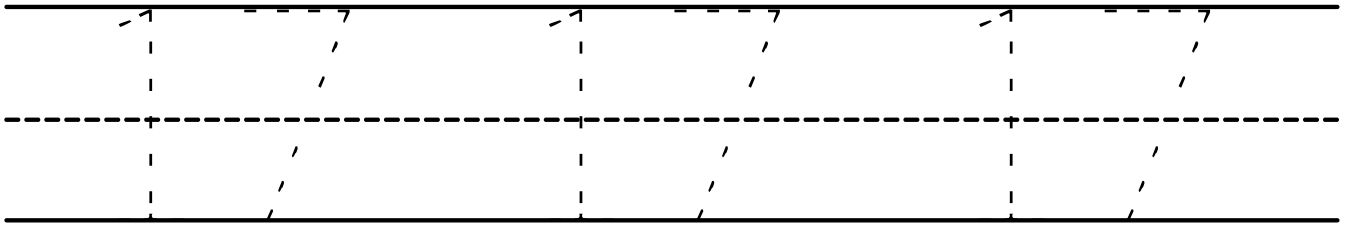

Belirtilen sayı kadar balığı keserek akvaryuma yapıştıralım.

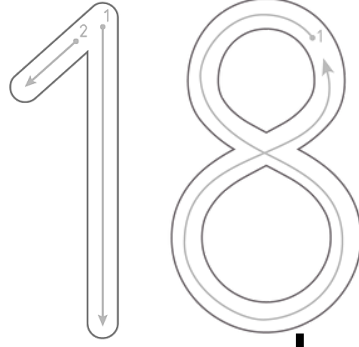

on sekiz

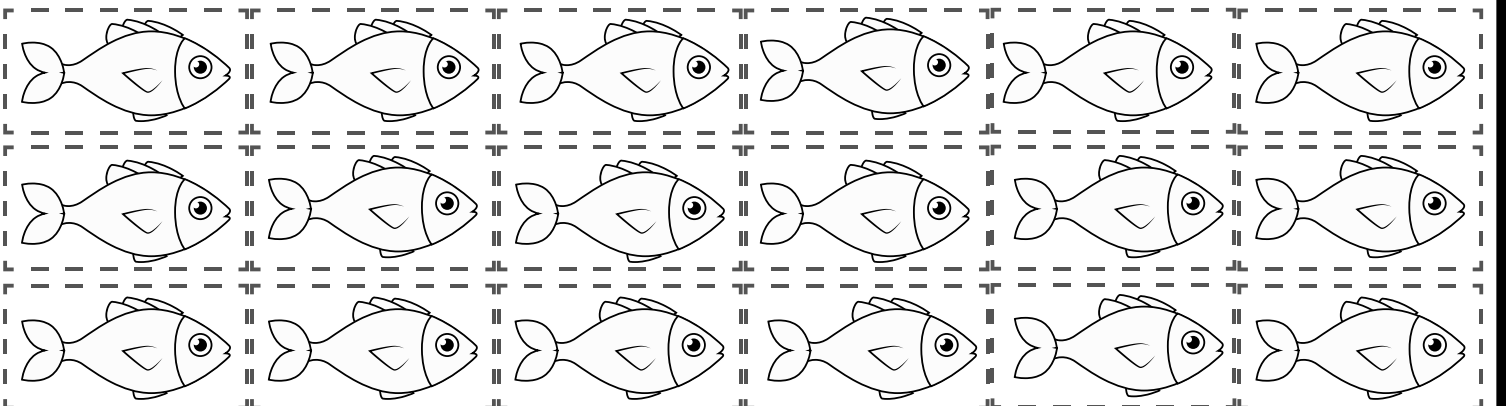
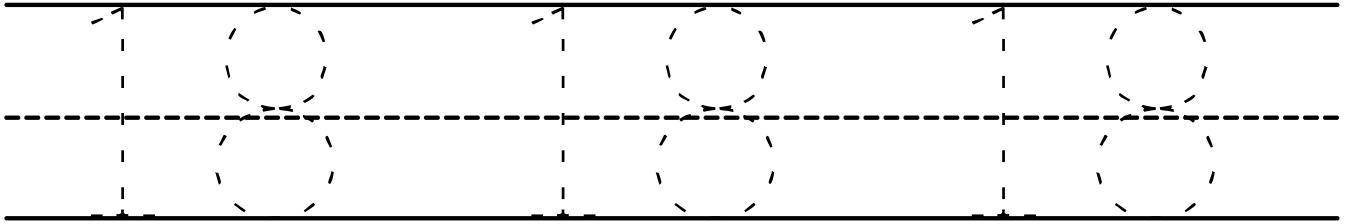

Belirtilen sayı kadar keki keserek tepsiye yapıştıralım.



on dokuz

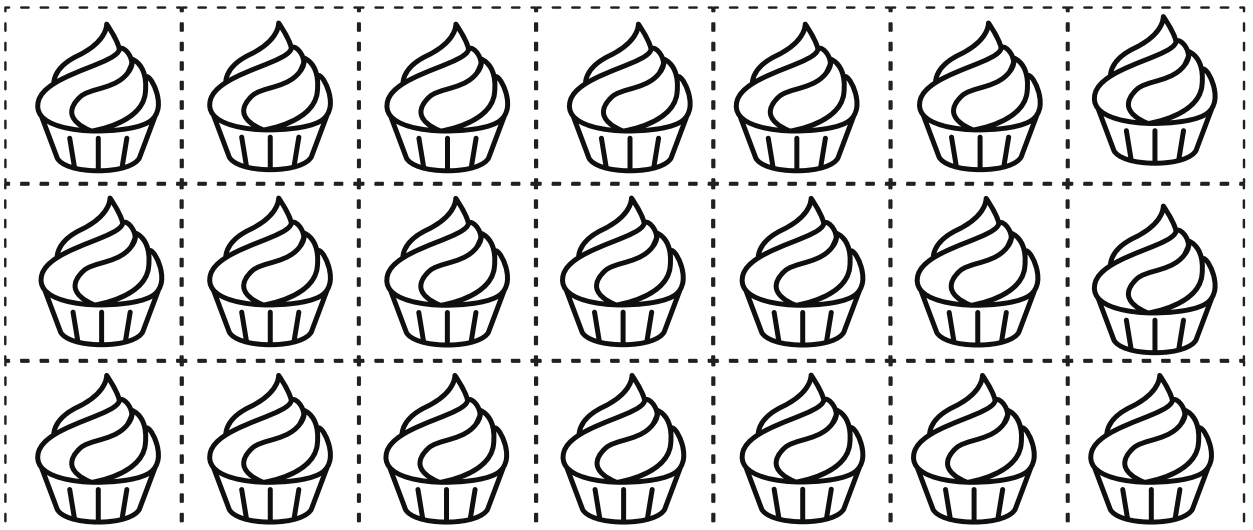
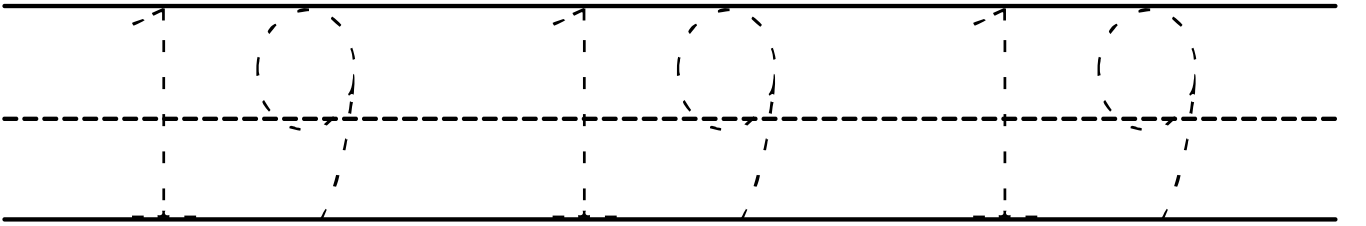
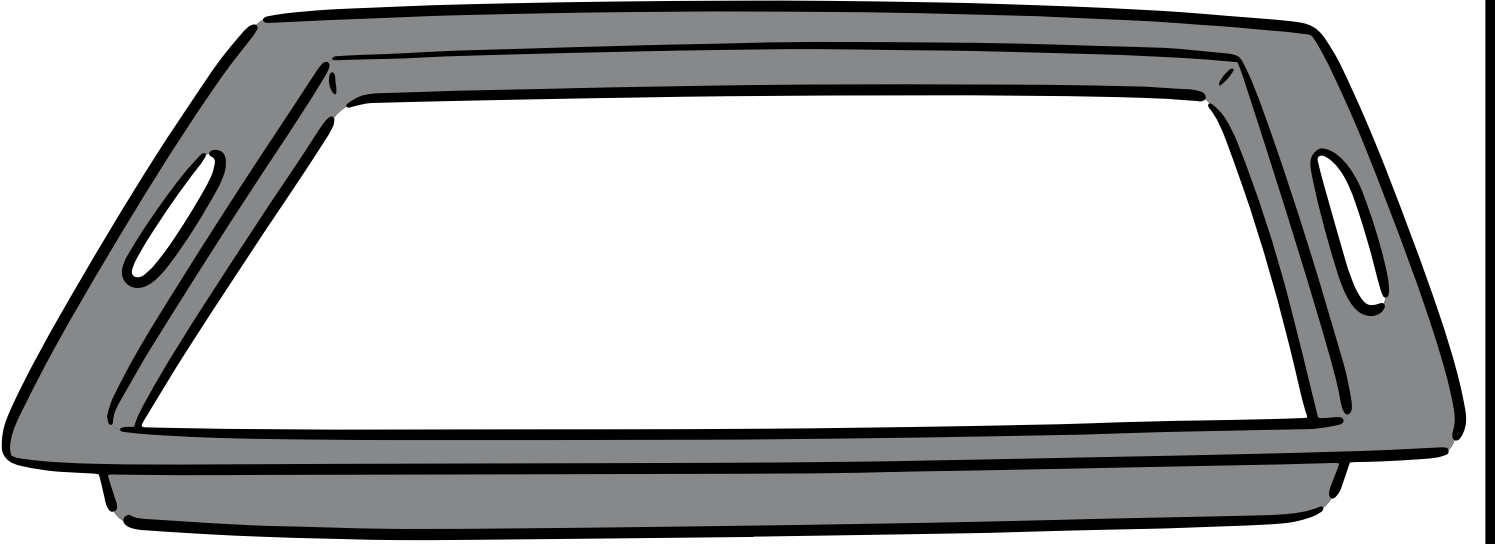

Belirtilen sayı kadar parayı keserek kumbaraya yapıştıralım.

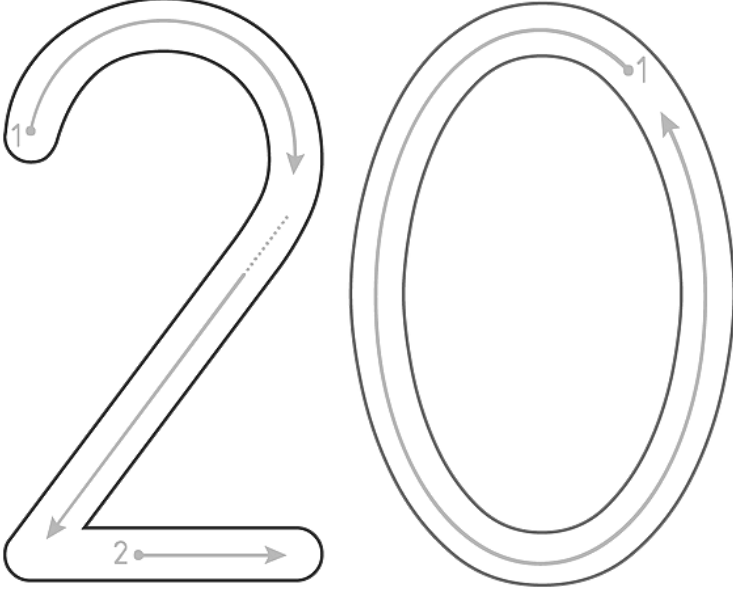

yirmi

